

## 18-BIT STEREO AUDIO CODEC, SINGLE-ENDED ANALOG INPUT/OUTPUT

### FEATURES

- **Monolithic 18-Bit  $\Delta\Sigma$  ADC and DAC**
- **16- or 18-Bit Input/Output Data**
- **Accepts Seven Alternate Formats**
- **Stereo ADC:**
  - **Single-Ended Voltage Input**
  - **64 $\times$  Oversampling Digital Filter**
    - **Pass-Band Ripple:  $\pm 0.05$  dB**
    - **Stop-Band Attenuation:  $-65$  dB**
  - **High Performance:**
    - **THD+N:  $-88$  dB**
    - **SNR: 94 dB**
    - **Dynamic Range: 94 dB**
  - **Digital High-Pass Filter**
- **Stereo DAC**
  - **Single-Ended Voltage Output**
  - **Analog Low-Pass Filter**
  - **8 $\times$  Oversampling Digital Filter**
    - **Pass-Band Ripple:  $\pm 0.17$  dB**
    - **Stop-Band Attenuation: 35 dB**
  - **High Performance:**
    - **THD+N:  $-90$  dB**
    - **SNR: 98 dB**
    - **Dynamic Range: 97 dB**
- **Special Features (PCM3000)**
  - **Digital De-Emphasis**
  - **Digital Attenuation (256 Steps)**
  - **Soft Mute**
  - **Digital Loopback**
- **Sample Rate: 4 kHz to 48 kHz**
- **System Clock: 256  $f_s$ , 384  $f_s$ , 512  $f_s$**

- **Single 5-V Power Supply**
- **Small Package: SSOP-28**

### APPLICATIONS

- **Sampling Keyboards**
- **Digital Mixers**
- **Mini-Disk Recorders**
- **Hard-Disk Recorders**
- **Karaoke Systems**
- **DSP-Based Car Stereo**
- **DAT Recorders**
- **Video Conferencing**

### DESCRIPTION

The PCM3000/3001 is a low-cost, single-chip stereo audio codec (analog-to-digital and digital-to-analog converter) with single-ended analog voltage input and output.

Both ADCs and DACs employ delta-sigma modulation with 64-times oversampling. The ADCs include a digital decimation filter and the DACs include an 8-times oversampling digital interpolation filter. The DACs also include digital attenuation, de-emphasis, infinite zero detection and soft mute to form a complete subsystem. The PCM3000/3001 operates with left-justified, right-justified, I<sup>2</sup>S or DSP data formats.

The PCM3000 can be programmed with a three-wire serial interface for special features and data formats. The PCM3001 can be pin-programmed for data formats.

The PCM3000 and PCM3001 are fabricated using a highly advanced CMOS process and are available in a small 28-pin SSOP package. The PCM3000/3001 are suitable for a wide variety of cost-sensitive consumer applications where good performance is required.

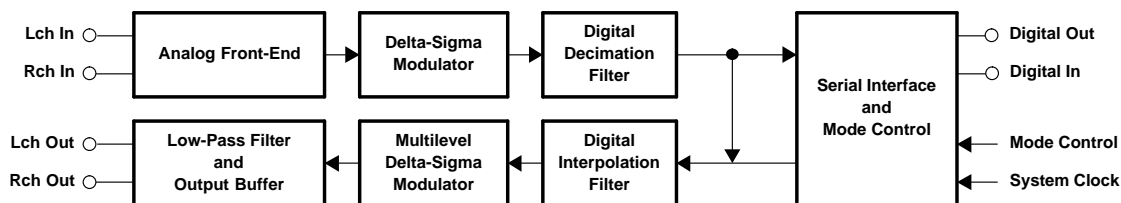

B0006-03



Please be aware that an important notice concerning availability, standard warranty, and use in critical applications of Texas Instruments semiconductor products and disclaimers thereto appears at the end of this data sheet.

System Two, Audio Precision are trademarks of Audio Precision, Inc.  
All other trademarks are the property of their respective owners.



This integrated circuit can be damaged by ESD. Texas Instruments recommends that all integrated circuits be handled with appropriate precautions. Failure to observe proper handling and installation procedures can cause damage.

ESD damage can range from subtle performance degradation to complete device failure. Precision integrated circuits may be more susceptible to damage because very small parametric changes could cause the device not to meet its published specifications.

## ELECTRICAL CHARACTERISTICS

All specifications at  $T_A = 25^\circ\text{C}$ ,  $V_{DD} = V_{CC} = 5\text{ V}$ ,  $f_S = 44.1\text{ kHz}$ ,  $\text{SYSCLK} = 384\text{ f}_S$ , CLKIO input, and 18-bit data, unless otherwise noted

PARAMETER		TEST CONDITIONS	MIN	TYP	MAX	UNIT
<b>DIGITAL INPUT/OUTPUT</b>						
<b>Input Logic</b>						
$V_{IH}^{(1)}$	Input logic level		2			VDC
$V_{IL}^{(1)}$					0.8	
$I_{IN}^{(2)}$	Input logic current				$\pm 1$	$\mu\text{A}$
$I_{IN}^{(3)}$					-120	
$V_{IH}^{(4)}$	Input logic level		$0.64 V_{DD}$			VDC
$V_{IL}^{(4)}$					$0.28 V_{DD}$	
$I_{IN}^{(4)}$	Input logic current				$\pm 40$	$\mu\text{A}$
<b>Output Logic</b>						
$V_{OH}^{(5)}$	Output logic level	$I_{OUT} = -1.6\text{ mA}$	4.5			VDC
$V_{OL}^{(5)}$		$I_{OUT} = 3.2\text{ mA}$			0.5	
$V_{OH}^{(6)}$	Output logic level	$I_{OUT} = -3.2\text{ mA}$	4.5			
$V_{OL}^{(6)}$		$I_{OUT} = 3.2\text{ mA}$			0.5	
<b>Clock Frequency</b>						
$f_S$	Sampling frequency		$4^{(7)}$	44.1	48	kHz
	System clock frequency	$256\text{ f}_S$	1.024	11.2896	12.288	MHz
		$384\text{ f}_S$	1.536	16.9344	18.432	
		$512\text{ f}_S$	2.048	22.5792	24.576	
<b>ADC CHARACTERISTICS</b>						
<b>Resolution</b>				18		Bits
<b>DC Accuracy</b>						
	Gain mismatch, channel-to-channel			$\pm 1$	$\pm 5$	% of FSR
	Gain error			$\pm 2$	$\pm 5$	
	Gain drift			$\pm 20$		ppm of FSR/ $^\circ\text{C}$
	Bipolar zero error	High-pass filter off <sup>(8)</sup>		$\pm 1.7$		% of FSR
	Bipolar zero drift	High-pass filter off <sup>(8)</sup>		$\pm 20$		ppm of FSR/ $^\circ\text{C}$

(1) Pins 16, 17, 18, 22, 25, 26, 27, 28: LRCIN, BCKIN, DIN, CLKIO, MC/FMT2, MD/FMT1, ML/FMT0, RSTB

(2) Pins 16, 17, 18, 22: LRCIN, BCKIN, DIN, CLKIO (Schmitt-trigger input)

(3) Pins 25, 26, 27, 28: MC/FMT2, MD/FMT1, ML/FMT0, RSTB (Schmitt-trigger input, 70-k $\Omega$  internal pullup resistor)

(4) Pin 20: XT1

(5) Pins 19, 22: DOUT, CLKIO

(6) Pin 21: XTO

(7) Refer to Application Bulletin [SBAA033](#) for information relating to operation at lower sampling frequencies.

(8) High-pass filter disabled (PCM3000 only) to measure dc offset

## ELECTRICAL CHARACTERISTICS (continued)

All specifications at  $T_A = 25^\circ\text{C}$ ,  $V_{DD} = V_{CC} = 5\text{ V}$ ,  $f_S = 44.1\text{ kHz}$ ,  $\text{SYSCLK} = 384 f_S$ , CLKIO input, and 18-bit data, unless otherwise noted

PARAMETER	TEST CONDITIONS	MIN	TYP	MAX	UNIT
<b>Dynamic Performance<sup>(9)</sup></b>					
THD+N	$f = 1\text{ kHz}$ , $V_{IN} = -0.5\text{ dB}$		-88	-80	dB
	$f = 1\text{ kHz}$ , $V_{IN} = -60\text{ dB}$		-31		
Dynamic range	$f = 1\text{ kHz}$ , A-weighted	90	94		dB
Signal-to-noise ratio	$f = 1\text{ kHz}$ , A-weighted	90	94		dB
Channel separation		88	92		dB
<b>Digital Filter Performance</b>					
Pass band				$0.454 f_S$	Hz
Stop band		$0.583 f_S$			Hz
Pass-band ripple				$\pm 0.05$	dB
Stop-band attenuation		-65			dB
Delay time (latency)			$17.4/f_S$		s
<b>Digital High-Pass Filter Response</b>					
Cutoff frequency	-3 dB		$0.019 f_S$		mHz
<b>ANALOG INPUT</b>					
Voltage range	0 dB (full scale)		2.9		Vp-p
Center voltage			2.1		VDC
Input impedance			15		k $\Omega$
<b>Antialiasing Filter</b>					
Cutoff frequency	-3 dB, $C_{EXT} = 470\text{ pF}$		170		kHz
<b>DAC CHARACTERISTICS</b>					
Resolution			18		Bits
<b>DC Accuracy</b>					
Gain mismatch, channel-to-channel			$\pm 1$	$\pm 5$	% of FSR
Gain error			$\pm 1$	$\pm 5$	% of FSR
Gain drift			$\pm 20$		ppm of FSR/ $^\circ\text{C}$
Bipolar zero error			$\pm 1$		% of FSR
Bipolar zero drift			$\pm 20$		ppm of FSR/ $^\circ\text{C}$
<b>Dynamic Performance<sup>(9)</sup></b>					
THD+N	$V_{OUT} = 0\text{ dB}$ (full scale)		-90	-80	dB
	$V_{OUT} = -60\text{ dB}$		-34		
Dynamic range	EIAJ A-weighted	90	97		dB
Signal-to-noise ratio (idle channel)	EIAJ A-weighted	92	98		dB
Channel separation		90	95		dB
<b>Digital Filter Performance</b>					
Pass band				$0.445 f_S$	Hz
Stop band		$0.555 f_S$			Hz
Pass-band ripple				$\pm 0.17$	dB
Stop-band attenuation		-35			dB
Delay time			$11.1/f_S$		s

(9)  $f_{IN} = 1\text{ kHz}$ , using the System Two™ audio measurement system by Audio Precision™, rms mode with 20-kHz LPF, 400-Hz HPF used for performance calculation or measurement.

## ELECTRICAL CHARACTERISTICS (continued)

All specifications at  $T_A = 25^\circ\text{C}$ ,  $V_{DD} = V_{CC} = 5\text{ V}$ ,  $f_s = 44.1\text{ kHz}$ ,  $\text{SYSCLK} = 384 f_s$ , CLKIO input, and 18-bit data, unless otherwise noted

PARAMETER		TEST CONDITIONS	MIN	TYP	MAX	UNIT
<b>Analog Output</b>						
Voltage range				0.62 $V_{CC}$		Vp-p
Center voltage				0.5 $V_{CC}$		VDC
Load impedance		AC load	5			k $\Omega$
<b>Analog Low-Pass Filter</b>						
Frequency response		$f = 20\text{ kHz}$		-0.16		dB
<b>POWER SUPPLY REQUIREMENTS</b>						
$V_{CC}$	Voltage range		4.5	5	5.5	VDC
$V_{DD}$			4.5	5	5.5	VDC
$I_{CC}, I_{DD}^{(10)}$	Supply current	$V_{CC} = V_{DD} = 5\text{ V}$		32	50	mA
	Power dissipation	$V_{CC} = V_{DD} = 5\text{ V}$		160	250	mW
<b>TEMPERATURE RANGE</b>						
$T_A$	Operation		-25		85	$^\circ\text{C}$
$T_{stg}$	Storage		-55		125	$^\circ\text{C}$
$\theta_{JA}$	Thermal resistance			100		$^\circ\text{C}/\text{W}$

(10) With no load on XTO and CLKIO

## PACKAGE/ORDERING INFORMATION

PRODUCT	PACKAGE	PACKAGE CODE	PACKAGE MARKING	ORDERING NUMBER	TRANSPORT MEDIA	QUANTITY
PCM3000E	28-pin SSOP	DB	PCM3000E	PCM3000E	Rails	47
				PCM3000E/2K	Tape and reel	2000
PCM3001E			PCM3001E	PCM3001E	Rails	47
				PCM3001E/2K	Tape and reel	2000

## ABSOLUTE MAXIMUM RATINGS

over operating free-air temperature range (unless otherwise noted)

Supply voltage: $V_{DD}, V_{CC1}, V_{CC2}$	-0.3 V to 6.5 V
Supply voltage differences	$\pm 0.1\text{ V}$
GND voltage differences	$\pm 0.1\text{ V}$
Digital input voltage	-0.3 to $V_{DD} + 0.3\text{ V}$ , < 6.5 V
Analog input voltage	-0.3 to $V_{CC1}, V_{CC2} + 0.3\text{ V}$ , < 6.5 V
Power dissipation	300 mW
Input current (any pins except supplies)	$\pm 10\text{ mA}$
Operating temperature	-25 $^\circ\text{C}$ to 85 $^\circ\text{C}$
Storage temperature	-55 $^\circ\text{C}$ to 125 $^\circ\text{C}$
Lead temperature, soldering	260 $^\circ\text{C}$ , 5 s
Package temperature (IR reflow, peak)	235 $^\circ\text{C}$

**RECOMMENDED OPERATING CONDITIONS**

over operating free-air temperature range (unless otherwise noted)

		<b>MIN</b>	<b>NOM</b>	<b>MAX</b>	<b>UNIT</b>
Analog supply voltage, $V_{CC1}$ , $V_{CC2}$		4.5	5	5.5	VDC
Digital supply voltage, $V_{DD}$		4.5	5	5.5	VDC
Analog input voltage, full scale (–0 dB)			2.9		Vp-p
Digital input logic family			TTL		
Digital input clock frequency	System clock	8.192		24.576	MHz
	Sampling clock	32		48	kHz
Analog output load resistance		5			k $\Omega$
Analog output load capacitance			50		pF
Digital output load capacitance			10		pF
Operating free-air temperature, $T_A$		–25		85	$^{\circ}$ C

**PIN CONFIGURATION—PCM3000/3001**

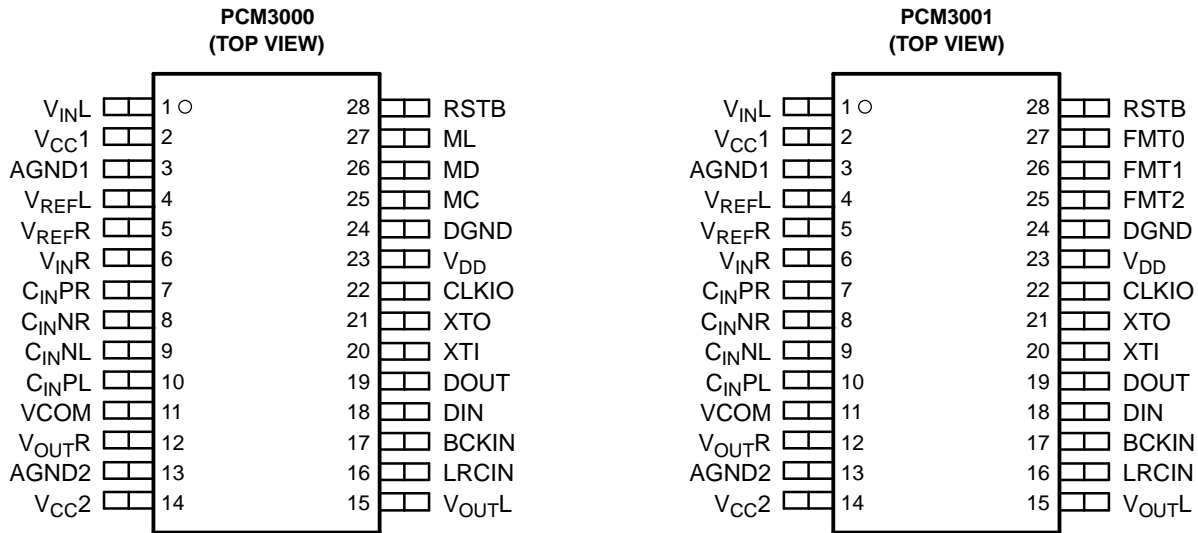

P0007-01

**PIN ASSIGNMENTS—PCM3000**

NAME	PIN	I/O	DESCRIPTION
AGND1	3	–	ADC analog ground
AGND2	13	–	DAC analog ground
BCKIN	17	I	Bit clock input <sup>(1)</sup>
C <sub>INNL</sub>	9	–	ADC antialias filter capacitor (–), Lch
C <sub>INNR</sub>	8	–	ADC antialias filter capacitor (–), Rch
C <sub>INPL</sub>	10	–	ADC antialias filter capacitor (+), Lch
C <sub>INPR</sub>	7	–	ADC antialias filter capacitor (+), Rch
CLKIO	22	I/O	Buffered oscillator output or external clock input <sup>(1)</sup>
DGND	24	–	Digital ground
DIN	18	I	Data input <sup>(1)</sup>
DOUT	19	O	Data output
LRCIN	16	I	Sample rate clock input (f <sub>s</sub> ) <sup>(1)</sup>
MC	25	I	Serial mode control, bit clock
MD	26	I	Serial mode control, data
ML	27	I	Serial mode control, strobe pulse
RSTB	28	I	Reset, active-low <sup>(1)(2)</sup>
V <sub>CC1</sub>	2	–	ADC analog power supply
V <sub>CC2</sub>	14	–	DAC analog power supply
V <sub>DD</sub>	23	–	Digital power supply
VCOM	11	–	DAC output common
V <sub>INL</sub>	1	I	ADC analog input, Lch
V <sub>INR</sub>	6	I	ADC analog input, Rch
V <sub>OUTL</sub>	15	O	DAC analog output, Lch
V <sub>OUTR</sub>	12	O	DAC analog output, Rch
V <sub>REFL</sub>	4	–	ADC input reference, Lch
V <sub>REFR</sub>	5	–	ADC input reference, Rch

(1) Schmitt-trigger input  
(2) With 70-kΩ typical internal pullup resistor

**PIN ASSIGNMENTS—PCM3000 (continued)**

NAME	PIN	I/O	DESCRIPTION
XTI	20	I	Oscillator input
XTO	21	O	Oscillator output

**PIN ASSIGNMENTS—PCM3001**

NAME	PIN	I/O	DESCRIPTION
AGND1	3	–	ADC analog ground
AGND2	13	–	DAC analog ground
BCKIN	17	I	Bit clock input <sup>(1)</sup>
C <sub>INL</sub>	9	–	ADC antialias filter capacitor (–), Lch
C <sub>INR</sub>	8	–	ADC antialias filter capacitor (–), Rch
C <sub>INPL</sub>	10	–	ADC antialias filter capacitor (+), Lch
C <sub>INPR</sub>	7	–	ADC antialias filter capacitor (+), Rch
CLKIO	22	I/O	Buffered oscillator output or external clock input <sup>(1)</sup>
DGND	24	–	Digital ground
DIN	18	I	Data input <sup>(1)</sup>
DOUT	19	O	Data output
FMT0	27	I	Audio data format control 0 <sup>(1)(2)</sup>
FMT1	26	I	Audio data format control 1 <sup>(1)(2)</sup>
FMT2	25	I	Audio data format control 2 <sup>(1)(2)</sup>
LRCIN	16	I	Sample rate clock input (f <sub>S</sub> ) <sup>(1)</sup>
RSTB	28	I	Reset, active-low <sup>(1)(2)</sup>
V <sub>CC1</sub>	2	–	ADC analog power supply
V <sub>CC2</sub>	14	–	DAC analog power supply
V <sub>DD</sub>	23	–	Digital power supply
VCOM	11	–	DAC output common
V <sub>INL</sub>	1	I	ADC analog input, Lch
V <sub>INR</sub>	6	I	ADC analog input, Rch
V <sub>OUTL</sub>	15	O	DAC analog output, Lch
V <sub>OUTR</sub>	12	O	DAC analog output, Rch
V <sub>REFL</sub>	4	–	ADC input reference, Lch
V <sub>REFR</sub>	5	–	ADC input reference, Rch
XTI	20	I	Oscillator input
XTO	21	O	Oscillator output

(1) Schmitt-trigger input

(2) With 70-k $\Omega$  typical internal pullup resistor

### TYPICAL PERFORMANCE CURVES OF ADC SECTION

All specifications at  $T_A = 25^\circ\text{C}$ ,  $V_{CC} = V_{DD} = 5\text{ V}$ ,  $f_{IN} = 1\text{ kHz}$ ,  $f_S = 44.1\text{ kHz}$ , 18-bit data,  $V_{IN} = 2.9\text{ Vp-p}$ , and  $\text{SYSCLK} = 384 f_S$ , unless otherwise noted

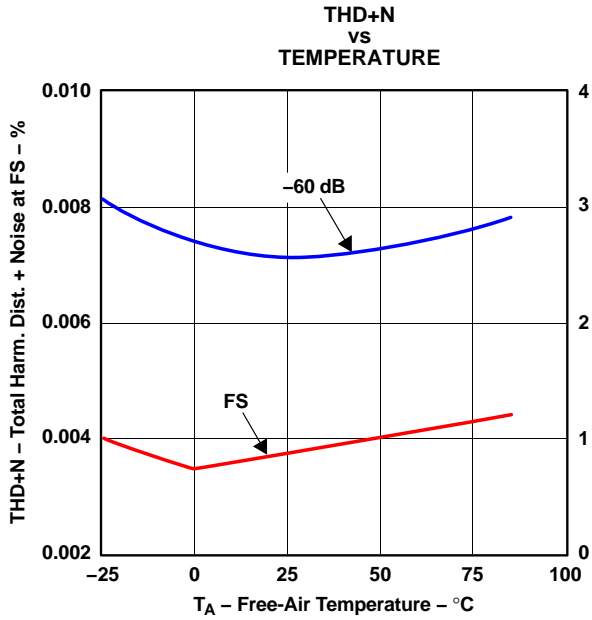

Figure 1.

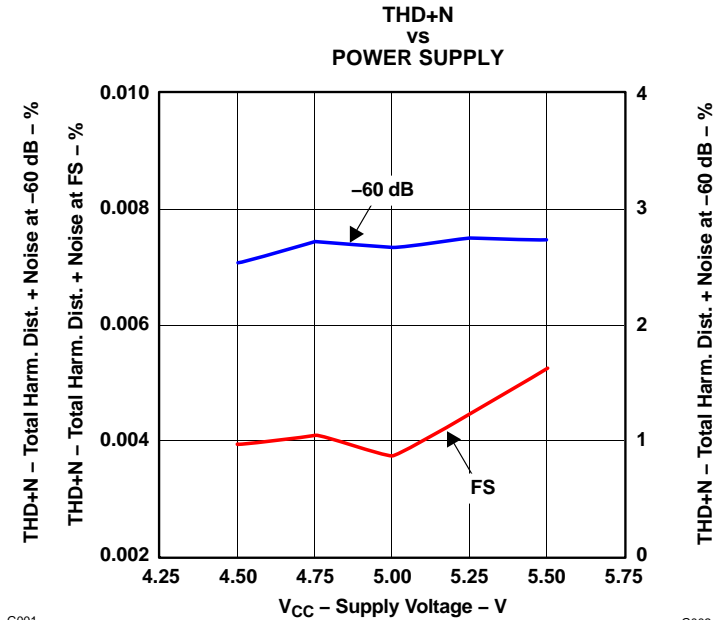

Figure 2.

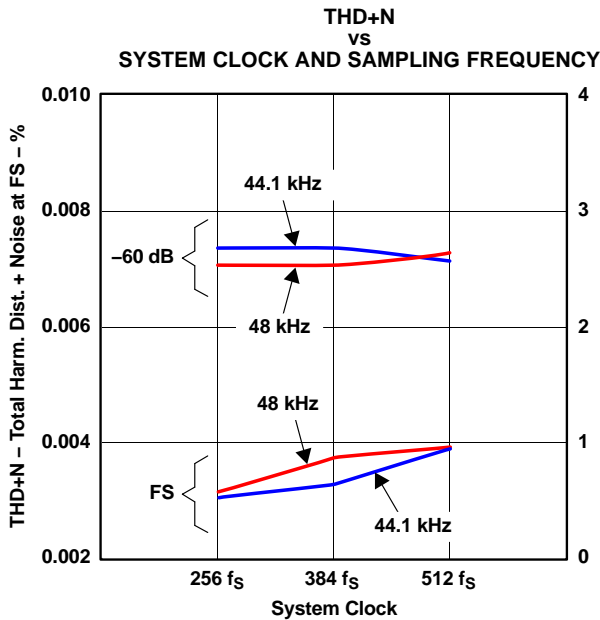

Figure 3.

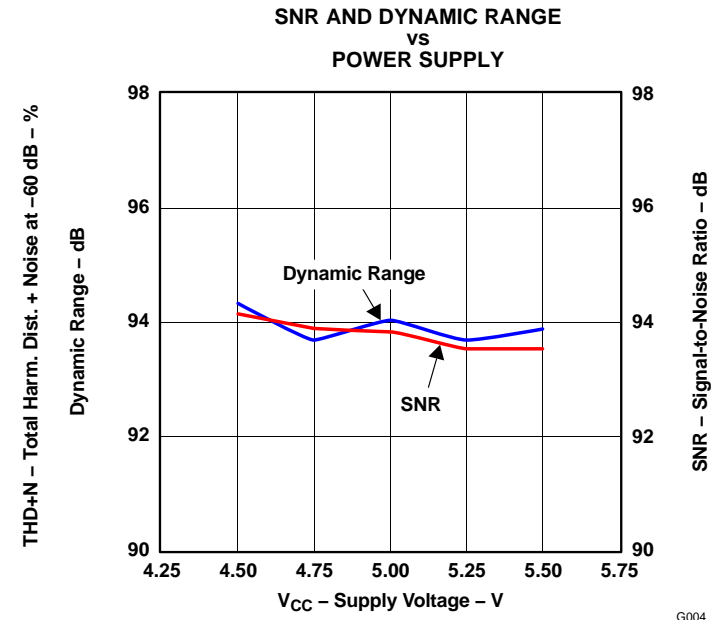

Figure 4.



### TYPICAL PERFORMANCE CURVES OF ADC SECTION (continued)

All specifications at  $T_A = 25^\circ\text{C}$ ,  $V_{CC} = V_{DD} = 5\text{ V}$ ,  $f_{IN} = 1\text{ kHz}$ ,  $f_S = 44.1\text{ kHz}$ , 18-bit data,  $V_{IN} = 2.9\text{ Vp-p}$ , and  $\text{SYSCLK} = 384\text{ f}_S$ , unless otherwise noted

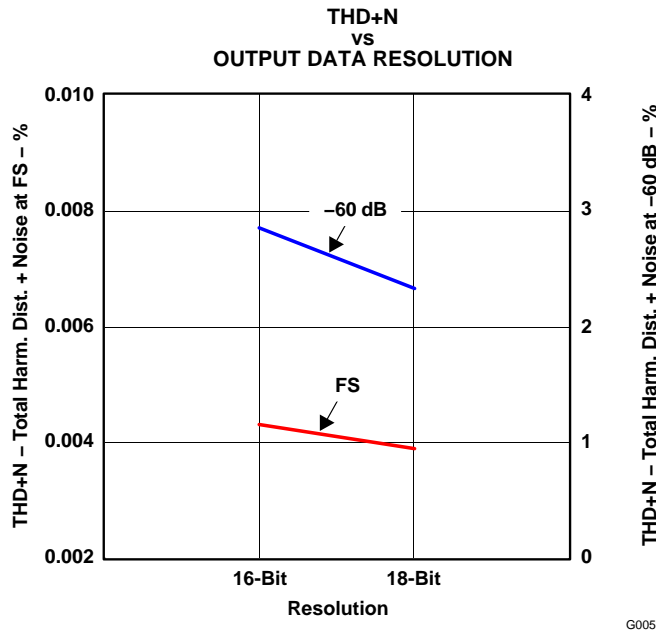

Figure 5.

### TYPICAL PERFORMANCE CURVES OF DAC SECTION

All specifications at  $T_A = 25^\circ\text{C}$ ,  $V_{CC} = V_{DD} = 5\text{ V}$ ,  $f_{IN} = 1\text{ kHz}$ ,  $f_S = 44.1\text{ kHz}$ , 18-bit data, and  $\text{SYSCLK} = 384\text{ f}_S$ , unless otherwise noted

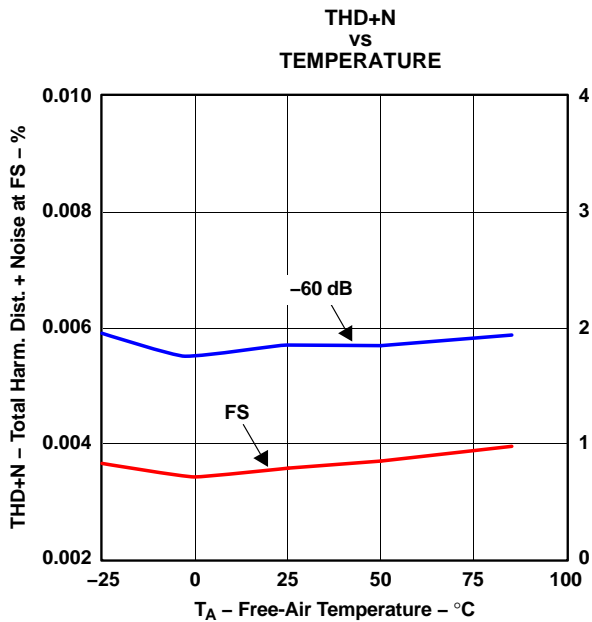

Figure 6.

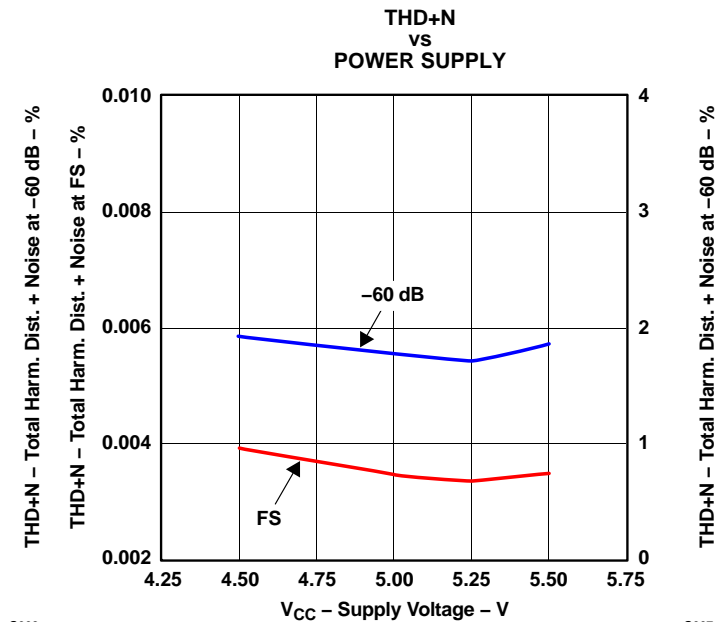

Figure 7.

### TYPICAL PERFORMANCE CURVES OF DAC SECTION (continued)

All specifications at  $T_A = 25^\circ\text{C}$ ,  $V_{CC} = V_{DD} = 5\text{ V}$ ,  $f_{IN} = 1\text{ kHz}$ ,  $f_S = 44.1\text{ kHz}$ , 18-bit data, and  $\text{SYSCLK} = 384\text{ f}_S$ , unless otherwise noted

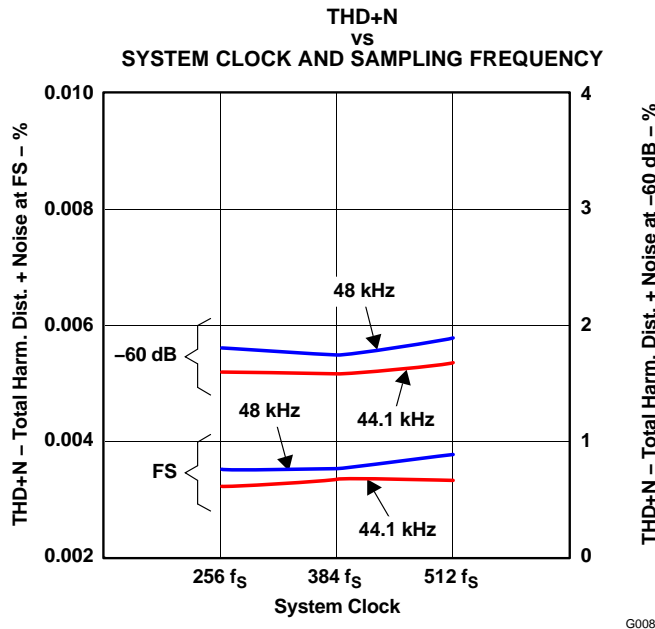

Figure 8.

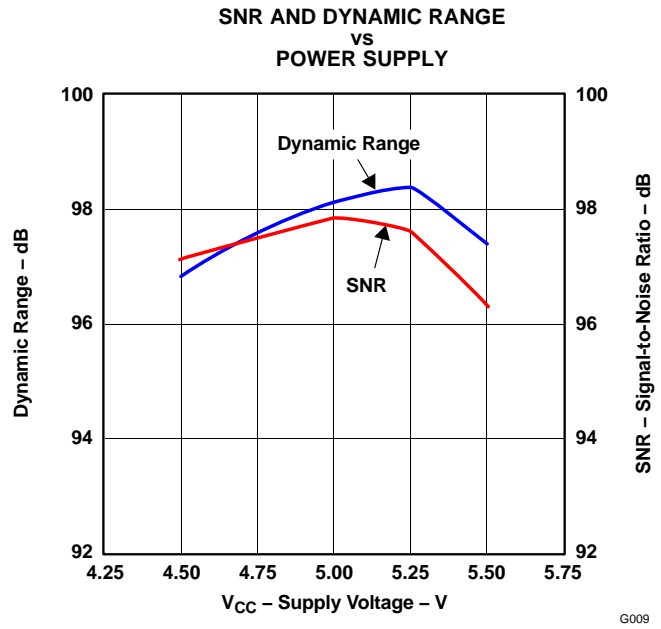

Figure 9.

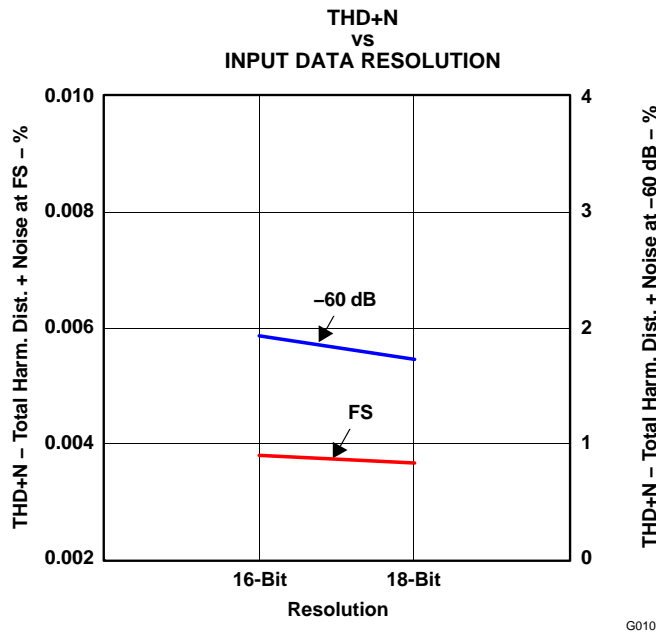

Figure 10.

## TYPICAL PERFORMANCE CURVES OF INTERNAL FILTERS (ADCs)

All specifications at  $T_A = 25^\circ\text{C}$ ,  $V_{CC} = V_{DD} = 5\text{ V}$ , and  $\text{SYSCLK} = 384\text{ f}_S$ , unless otherwise noted

### DECIMATION FILTER

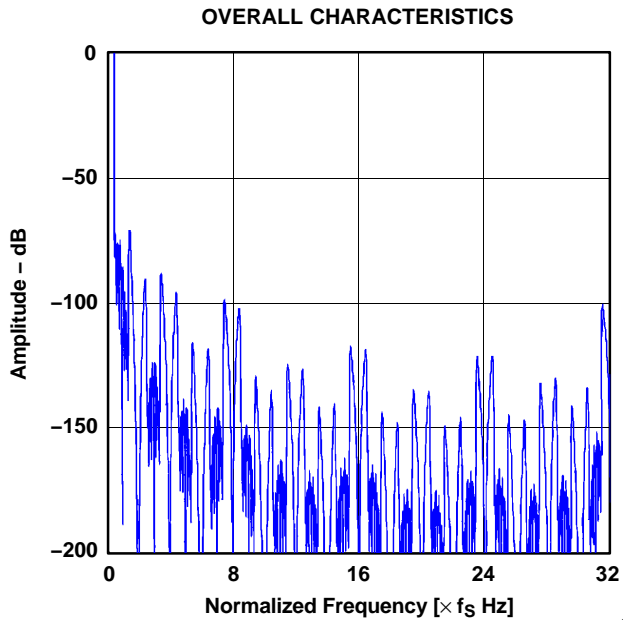

Figure 11.

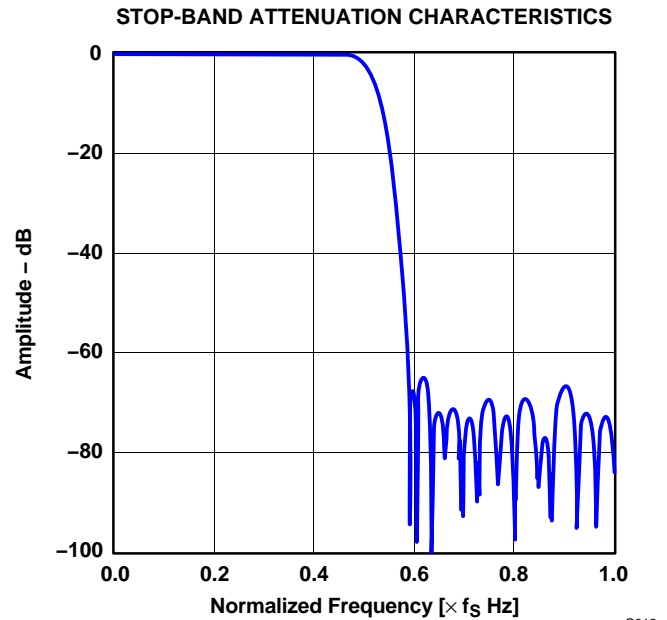

Figure 12.

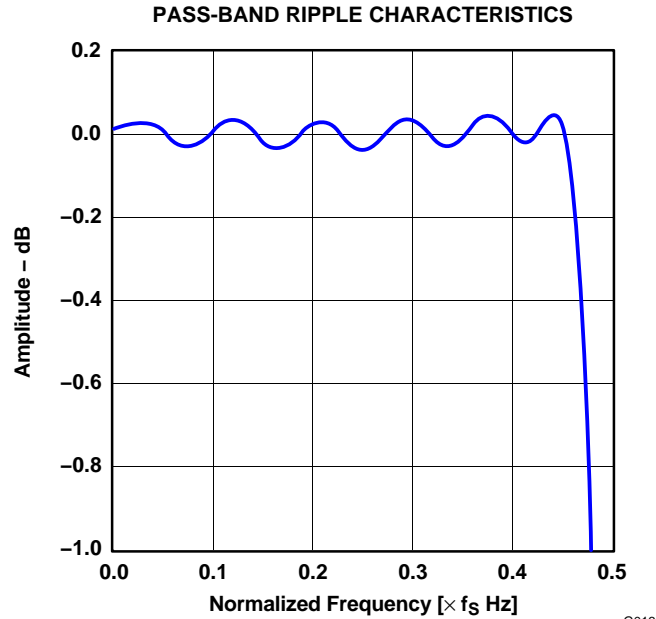

Figure 13.

## TYPICAL PERFORMANCE CURVES OF INTERNAL FILTERS (ADCs) (continued)

All specifications at  $T_A = 25^\circ\text{C}$ ,  $V_{CC} = V_{DD} = 5\text{ V}$ , and  $\text{SYSCLK} = 384 f_S$ , unless otherwise noted

### HIGH-PASS FILTER

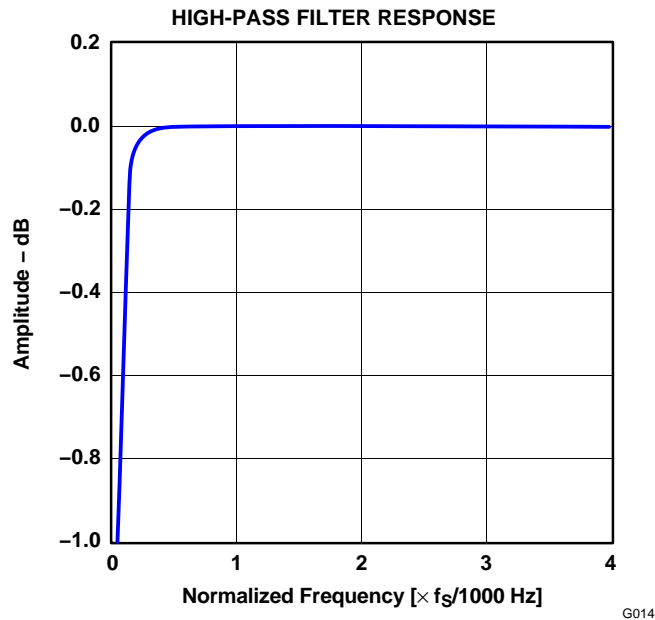

Figure 14.

### ANTI\_ALIASING FILTER

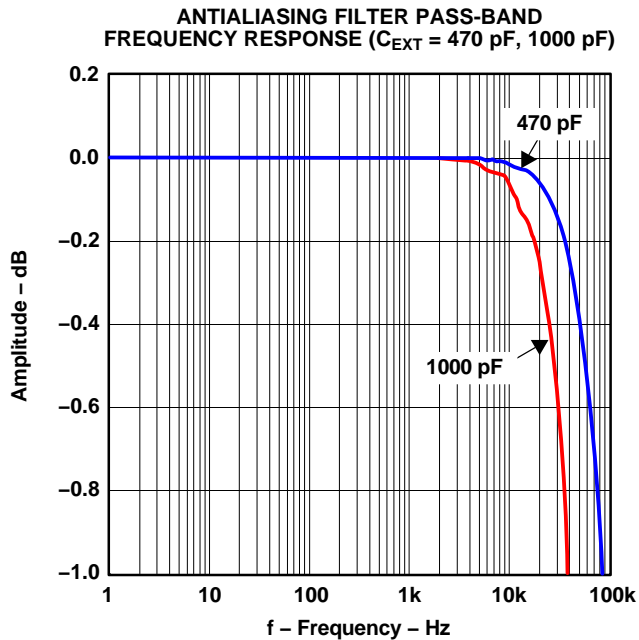

Figure 15.

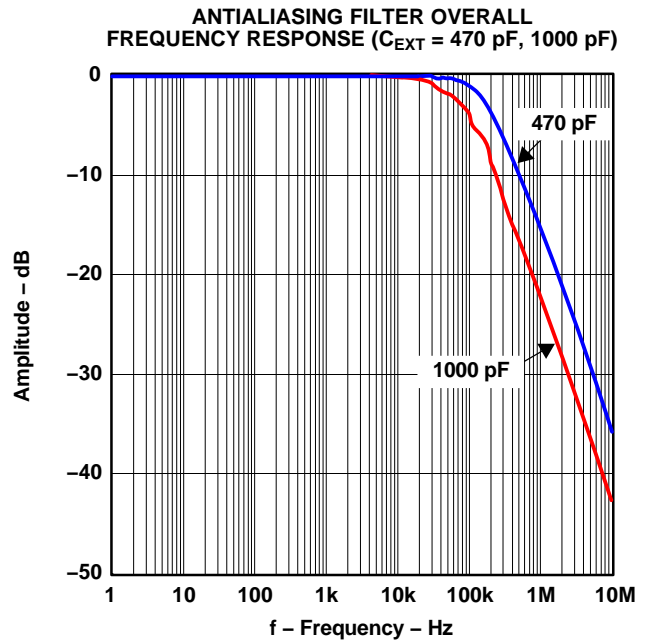

Figure 16.

## TYPICAL PERFORMANCE CURVES OF INTERNAL FILTERS (DACs)

All specifications at  $T_A = 25^\circ\text{C}$ ,  $V_{CC} = V_{DD} = 5\text{ V}$ , and  $\text{SYSCLK} = 384\text{ f}_S$ , unless otherwise noted

### DIGITAL FILTER

OVERALL FREQUENCY CHARACTERISTIC

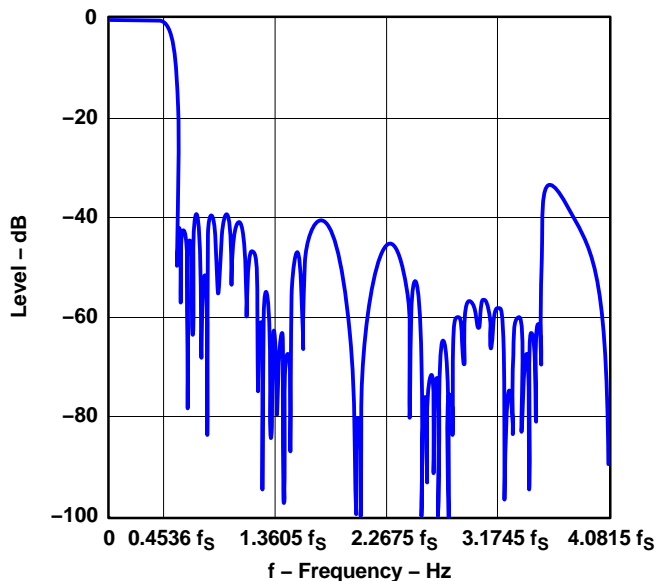

G017

PASS-BAND RIPPLE CHARACTERISTIC

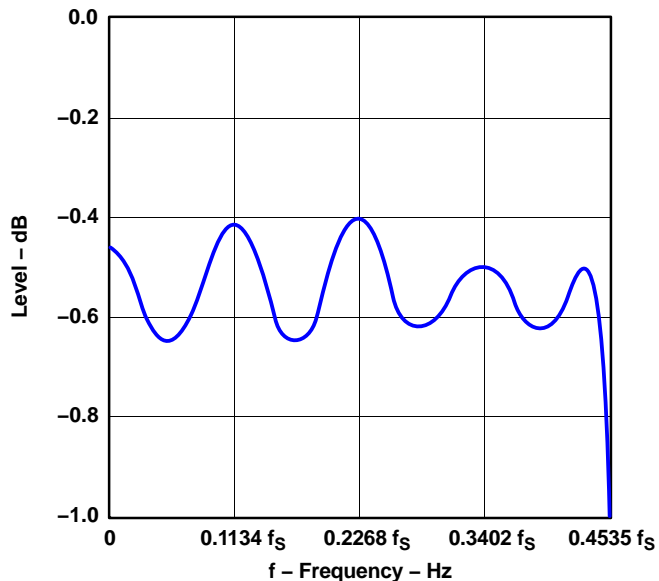

G018

### DE-EMPHASIS FILTER

DE-EMPHASIS FREQUENCY RESPONSE (32 kHz)

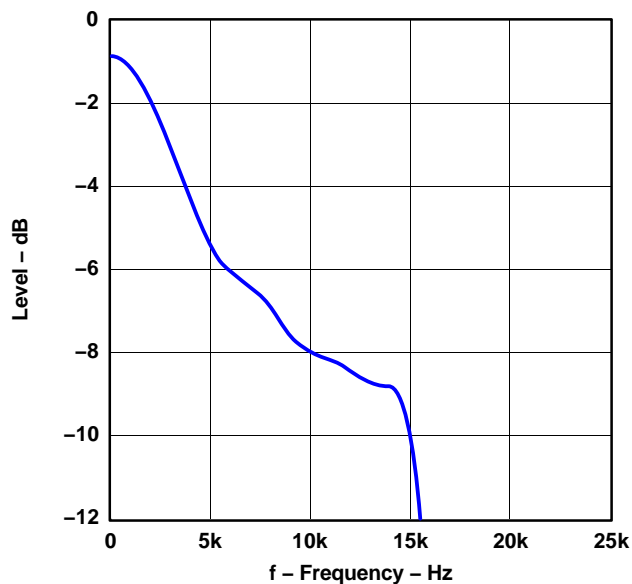

G019

DE-EMPHASIS ERROR (32 kHz)

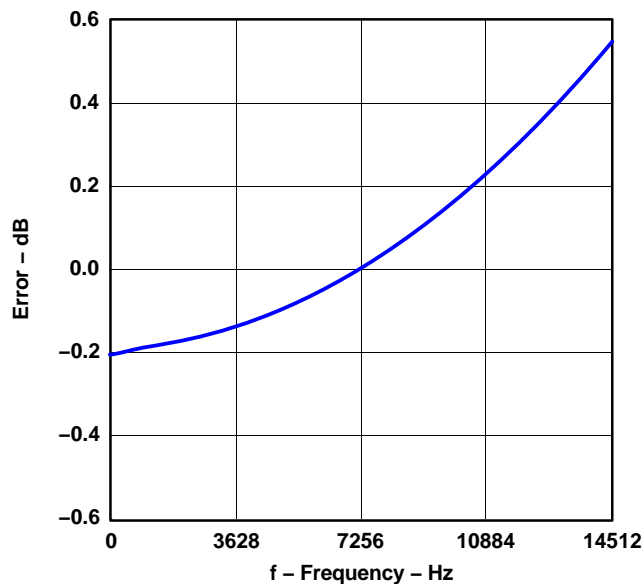

G020

**TYPICAL PERFORMANCE CURVES OF INTERNAL FILTERS (DACs) (continued)**

All specifications at  $T_A = 25^\circ\text{C}$ ,  $V_{CC} = V_{DD} = 5\text{ V}$ , and  $\text{SYSCLK} = 384\text{ f}_S$ , unless otherwise noted

DE-EMPHASIS FREQUENCY RESPONSE (44.1 kHz)

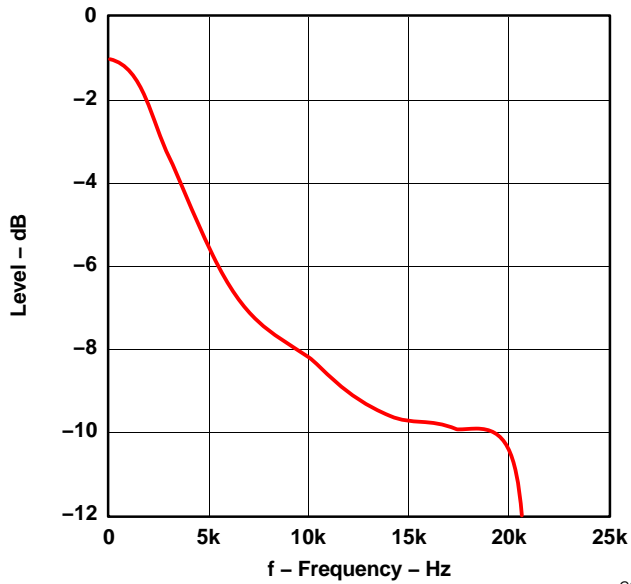

G021

DE-EMPHASIS ERROR (44.1 kHz)

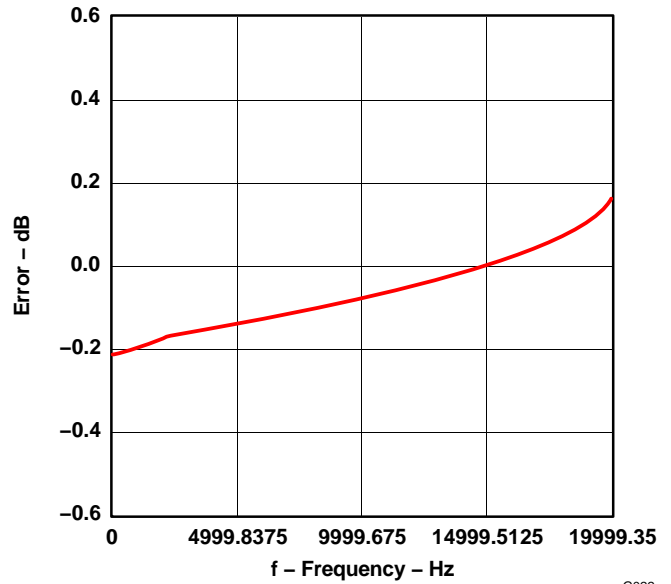

G022

DE-EMPHASIS FREQUENCY RESPONSE (48 kHz)

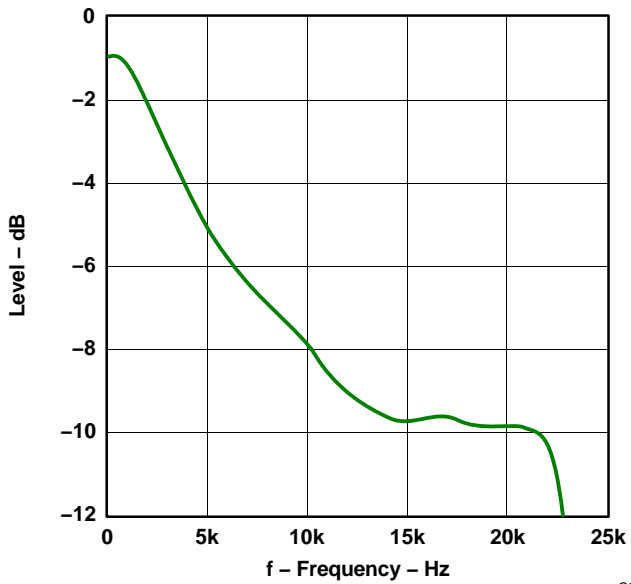

G023

DE-EMPHASIS ERROR (48 kHz)

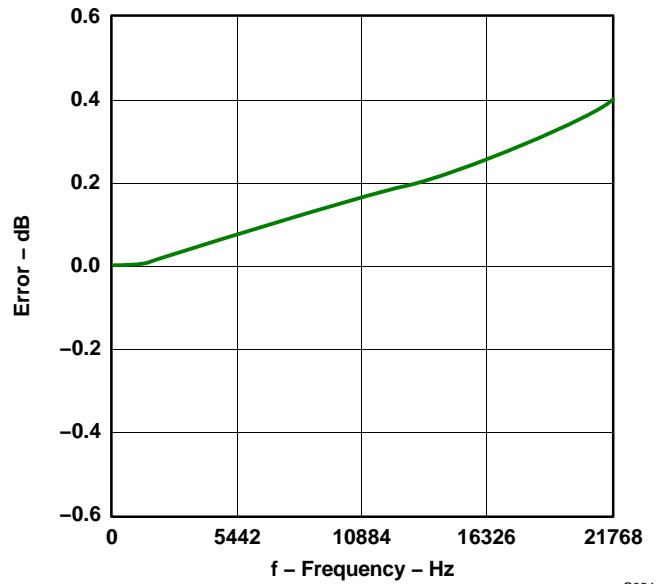

G024

## TYPICAL PERFORMANCE CURVES OF INTERNAL FILTERS (DACs) (continued)

All specifications at  $T_A = 25^\circ\text{C}$ ,  $V_{CC} = V_{DD} = 5\text{ V}$ , and  $\text{SYSCLK} = 384\text{ f}_S$ , unless otherwise noted

### ANALOG LOW-PASS FILTER

INTERNAL ANALOG FILTER FREQUENCY RESPONSE  
(20 Hz–24 kHz, EXPANDED SCALE)

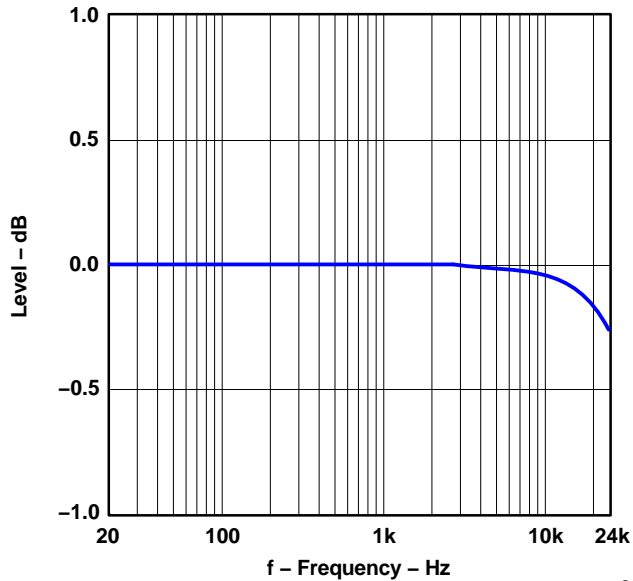

INTERNAL ANALOG FILTER FREQUENCY RESPONSE  
(10 Hz–10 MHz)

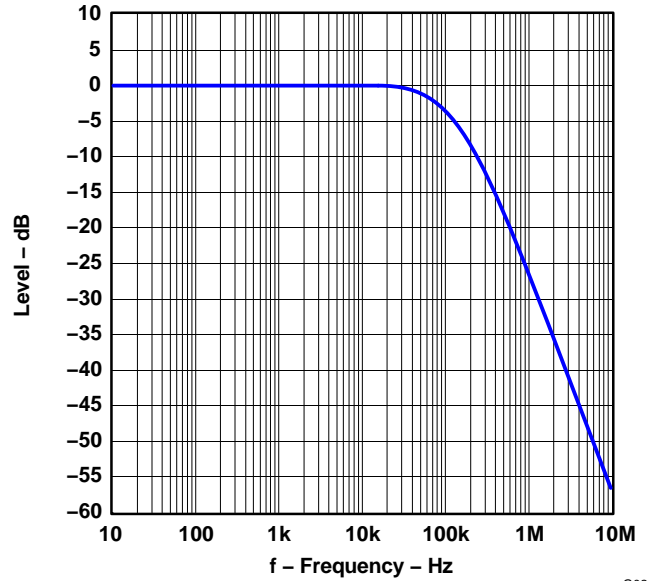

Block Diagram

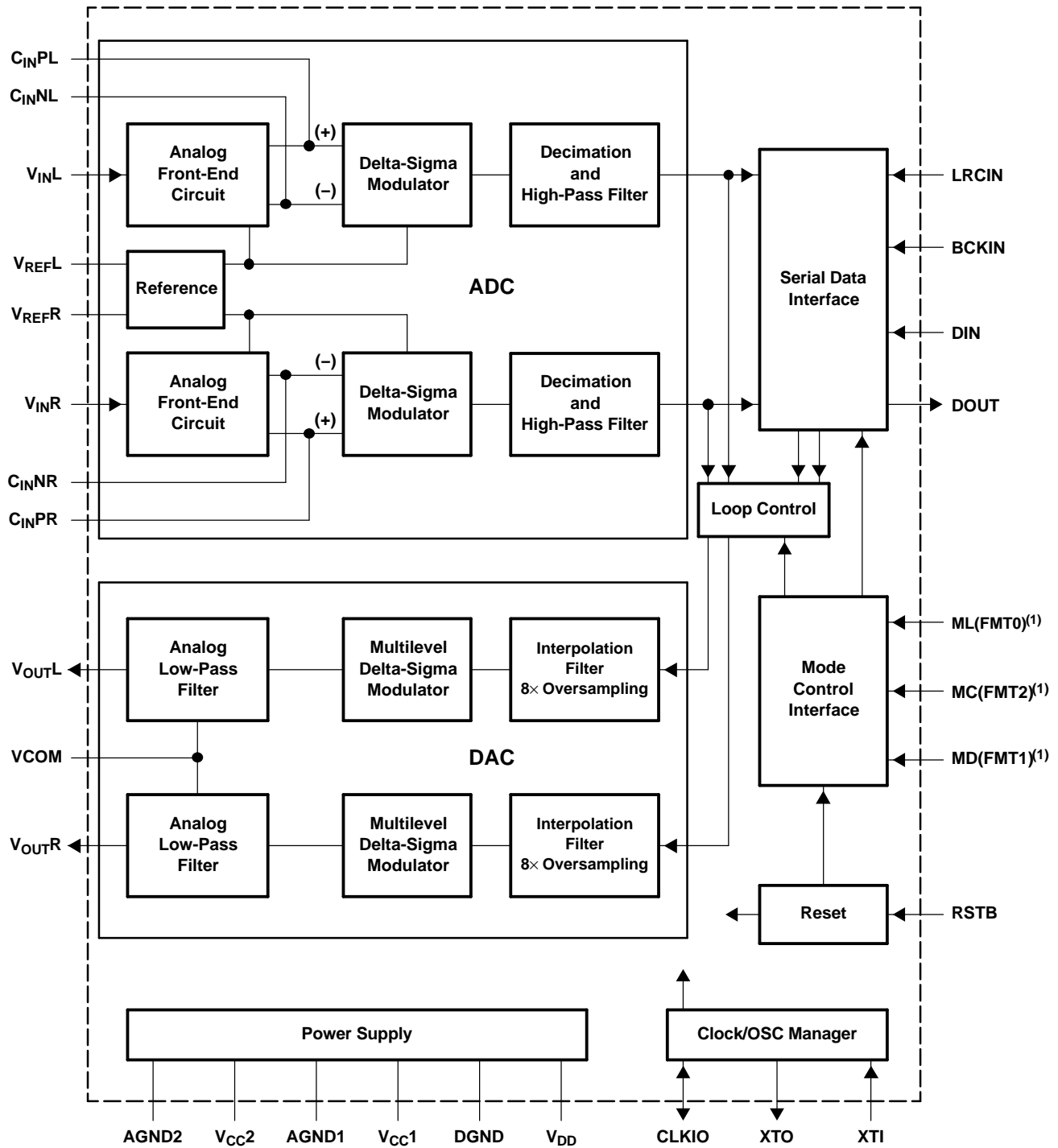

B0004-05



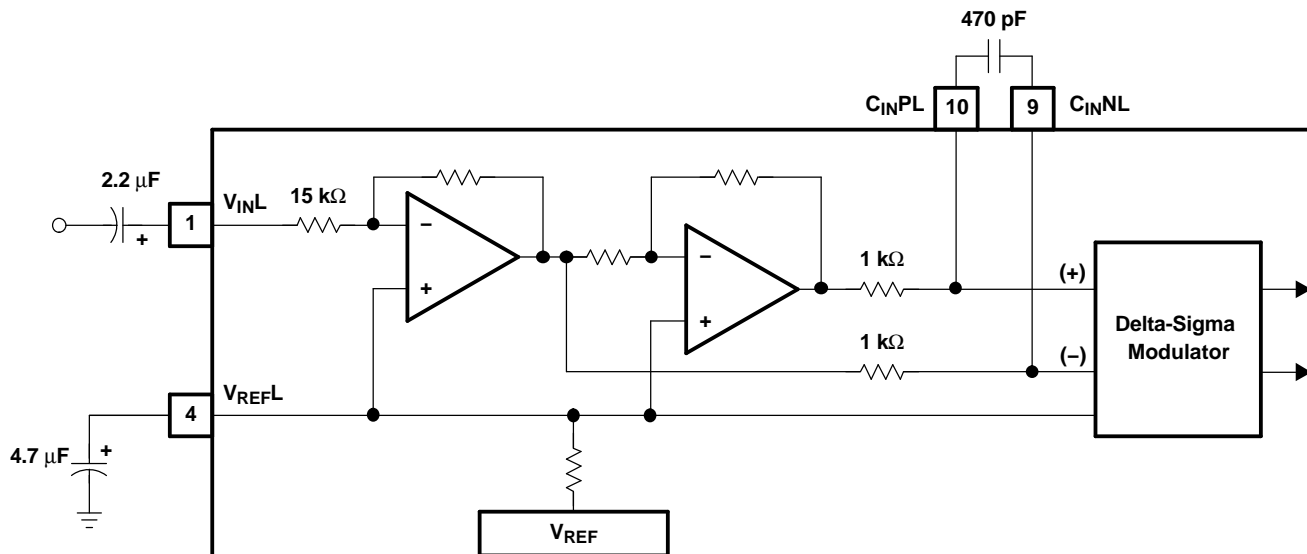

S0011-04

**Figure 17. Analog Front-End (Single-Channel)**

## PCM AUDIO INTERFACE

The four-wire digital audio interface for the PCM3000/3001 is on LRCIN (pin 16), BCKIN (pin 17), DIN (pin 18), and DOUT (pin 19). The PCM3000/3001 can operate with seven different data formats. For the PCM3000, these formats are selected through program register 3 in the software mode. For the PCM3001, data formats are selected by pin-strapping the three format pins. Figure 18, Figure 19, Figure 20 and Figure 21 illustrate the audio data input/output format. Figure 22 shows the audio data input/output timing. The PCM3000/3001 can accept 32, 48, or 64 bit clocks (BCKIN) during one clock of LRCIN. Only formats 0, 2, and 6 can be selected when 32 bit clocks/LRCIN are applied.

**FORMAT 0: FMT[2:0] = 000**

DAC: 16-Bit, MSB-First, Right-Justified

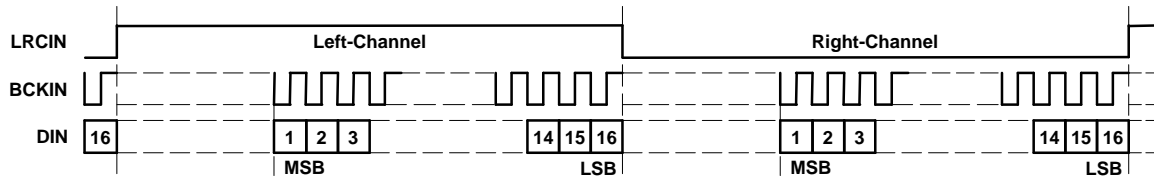

ADC: 16-Bit, MSB-First, Left-Justified

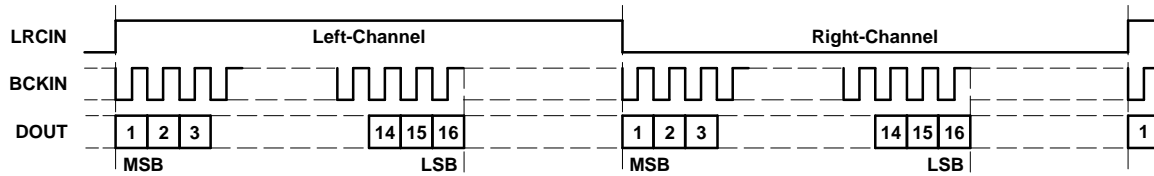

**FORMAT 1: FMT[2:0] = 001**

DAC: 18-Bit, MSB-First, Right-Justified

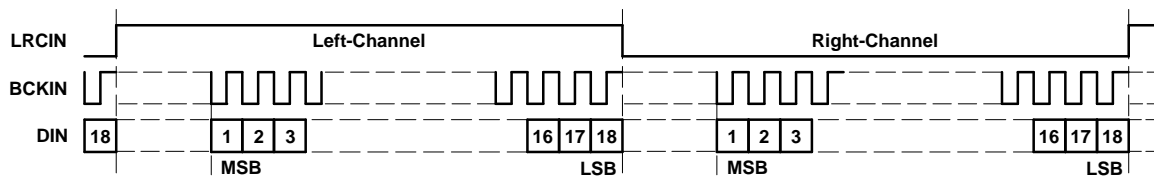

ADC: 18-Bit, MSB-First, Left-Justified

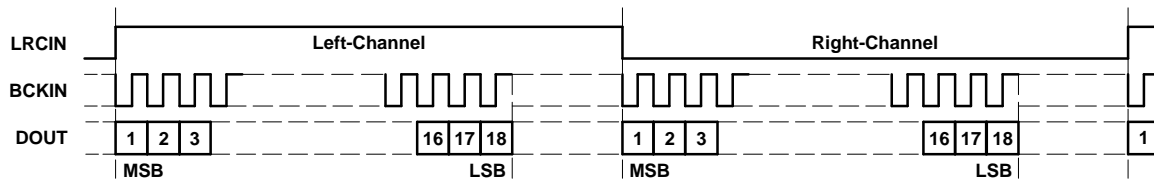

T0016-07

Figure 18. Audio Data Input/Output Format (Formats 0 and 1)

**FORMAT 2: FMT[2:0] = 010**

DAC: 16-Bit, MSB-First, Right-Justified

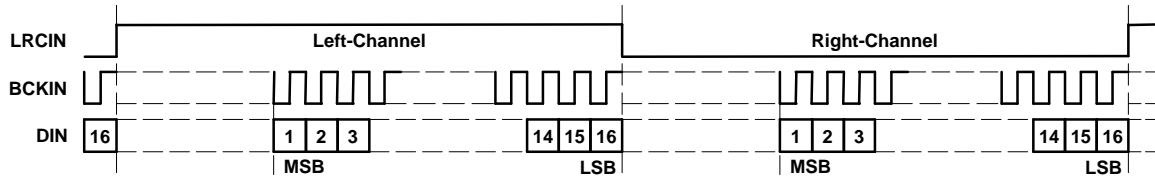

ADC: 16-Bit, MSB-First, Right-Justified

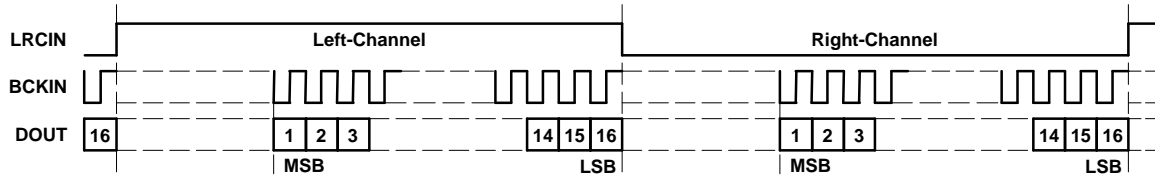

**FORMAT 3: FMT[2:0] = 011**

DAC: 18-Bit, MSB-First, Right-Justified

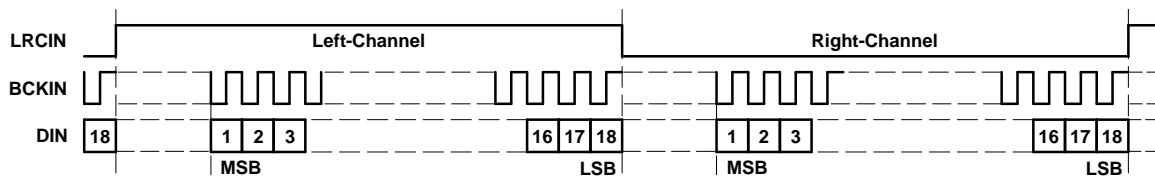

ADC: 18-Bit, MSB-First, Right-Justified

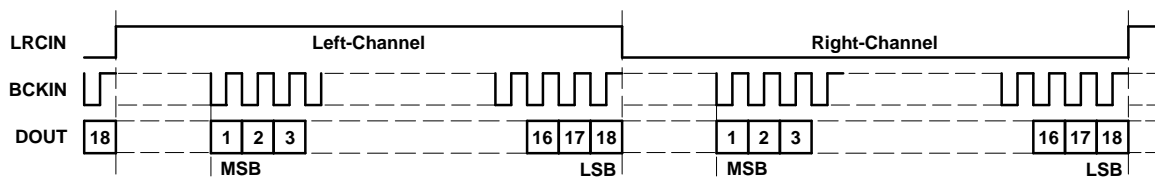

T0016-08

**Figure 19. Audio Data Input/Output Format (Formats 2 and 3)**

**FORMAT 4: FMT[2:0] = 100**

DAC: 18-Bit, MSB-First, Left-Justified

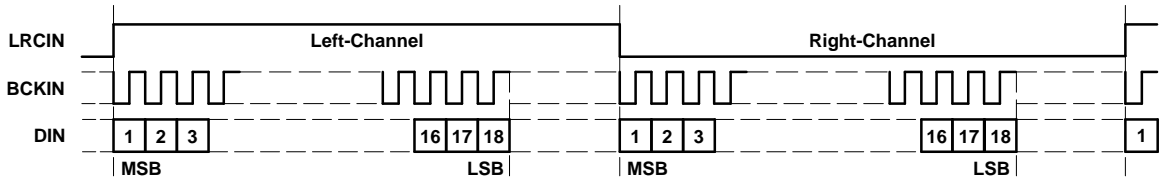

ADC: 18-Bit, MSB-First, Left-Justified

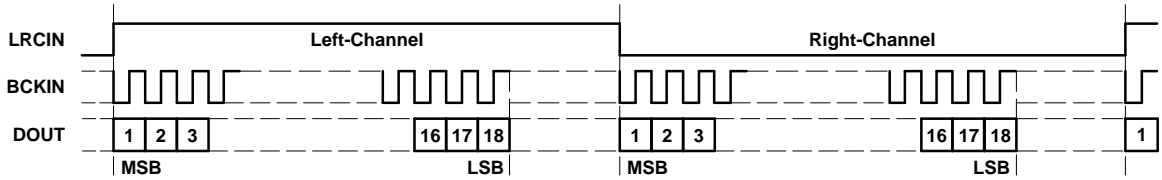

**FORMAT 5: FMT[2:0] = 101**

DAC: 18-Bit, MSB-First, I<sup>2</sup>S

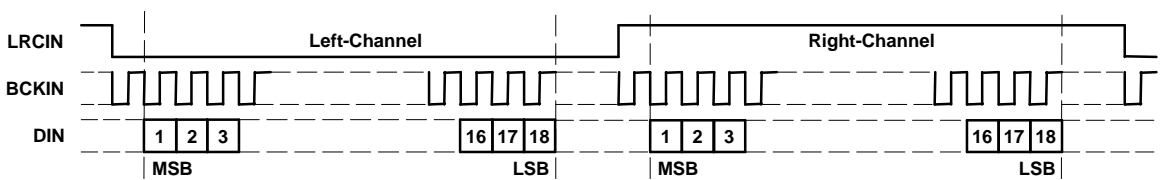

ADC: 18-Bit, MSB-First, I<sup>2</sup>S

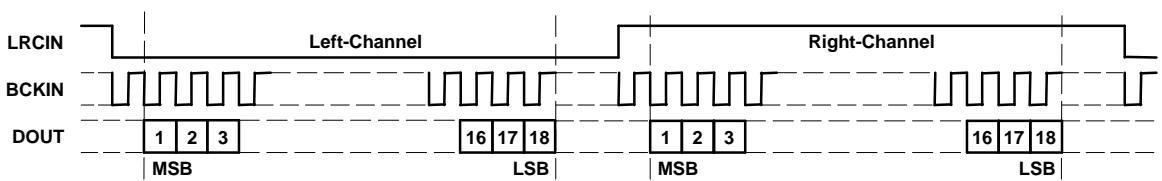

T0016-09

**Figure 20. Audio Data Input/Output Format (Formats 4 and 5)**

**FORMAT 6: FMT[2:0] = 110**

DAC: 16-Bit, MSB-First, DSP-Frame

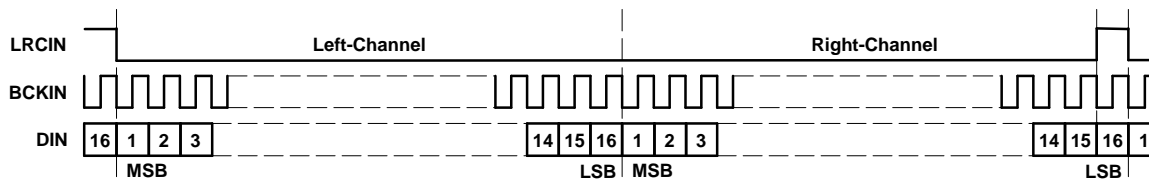

ADC: 16-Bit, MSB-First, DSP-Frame

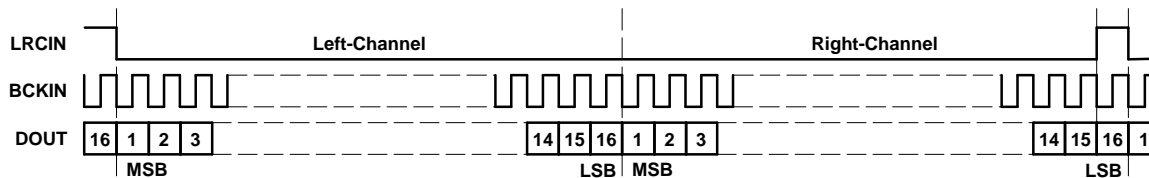

T0016-10

**Figure 21. Audio Data Input/Output Format (Format 6)**

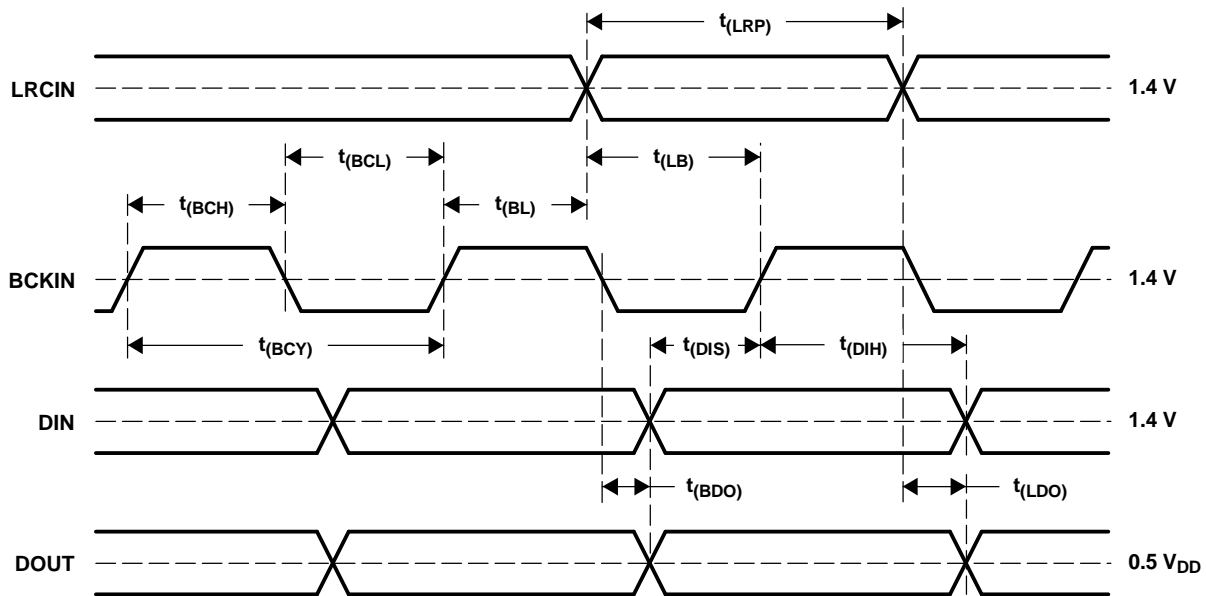

T0021-02

BCKIN pulse cycle time	$t_{(BCY)}$	300 ns (min)
BCKIN pulse duration, HIGH	$t_{(BCH)}$	120 ns (min)
BCKIN pulse duration, LOW	$t_{(BCL)}$	120 ns (min)
BCKIN rising edge to LRCIN edge	$t_{(BL)}$	40 ns (min)
LRCIN edge to BCKIN rising edge	$t_{(LB)}$	40 ns (min)
LRCIN pulse duration	$t_{(LRP)}$	$t_{(BCY)}$ (min)
DIN setup time	$t_{(DIS)}$	40 ns (min)
DIN hold time	$t_{(DIH)}$	40 ns (min)
DOUT delay time to BCKIN falling edge	$t_{(BDO)}$	40 ns (max)
DOUT delay time to LRCIN edge	$t_{(LDO)}$	40 ns (max)
Rising time of all signals	$t_{(RISE)}$	20 ns (max)
Falling time of all signals	$t_{(FALL)}$	20 ns (max)

Figure 22. Audio Data Input/Output Timing

## SYSTEM CLOCK

The system clock for the PCM3000/3001 must be either  $256 f_s$ ,  $384 f_s$ , or  $512 f_s$ , where  $f_s$  is the audio sampling frequency. The system clock can be either a crystal oscillator placed between XTI (pin 20) and XTO (pin 21), or an external clock input. If an external clock is used, the clock is provided to either XTI or CLKIO (pin 22), and XTO is open. The PCM3000/3001 has an XTI clock detection circuit which senses if an XTI clock is operating. When the external clock is delivered to XTI, CLKIO is a buffered output of XTI. When XTI is connected to ground, the external clock must be tied to CLKIO. For best performance, the external-clock-input-2 circuit in Figure 23 is recommended.

The PCM3000/3001 also has a system-clock detection circuit which automatically senses if the system clock is operating at  $256 f_s$ ,  $384 f_s$ , or  $512 f_s$ . When a  $384 f_s$  or  $512 f_s$  system clock is used, the clock is divided into  $256 f_s$  automatically. The  $256 f_s$  clock is used to operate the digital filters and the modulators.

Table 1 lists the relationship of typical sampling frequencies and system clock frequencies, and Figure 23 and Figure 24 illustrate the typical system clock connections and external system clock timing.

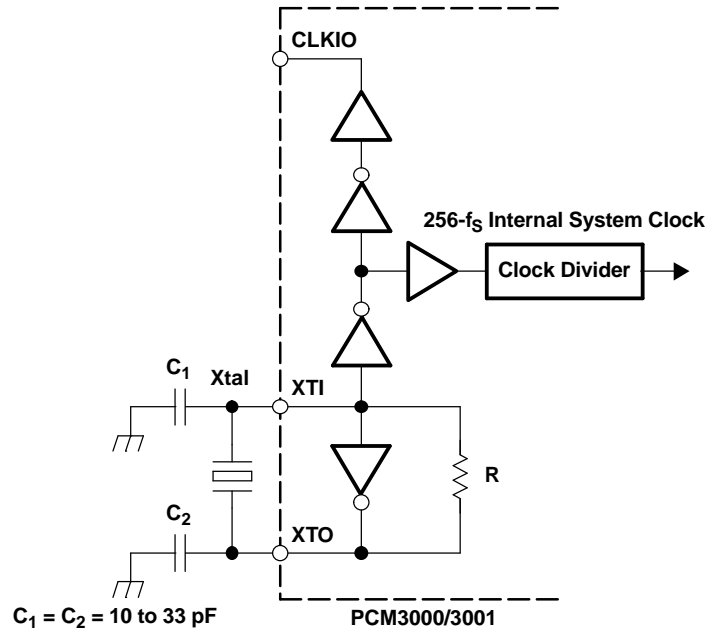

Crystal Resonator Connection (Xtal must be fundamental mode, parallel resonant)

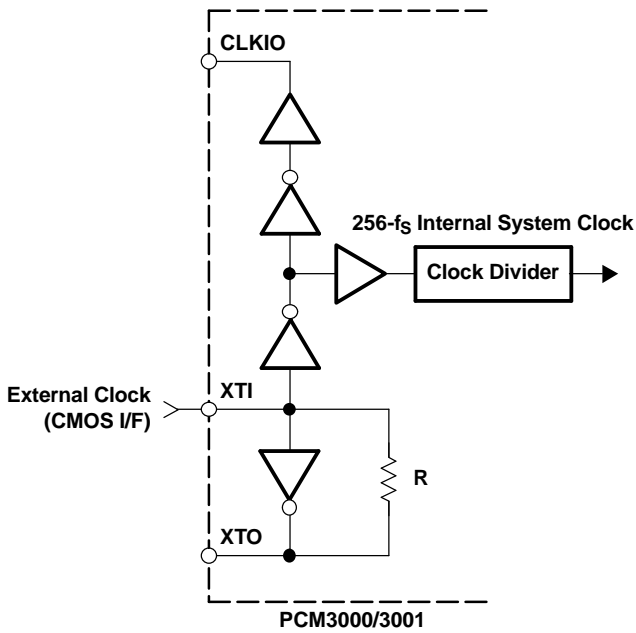

External Clock Input 1 : (XTO is open)

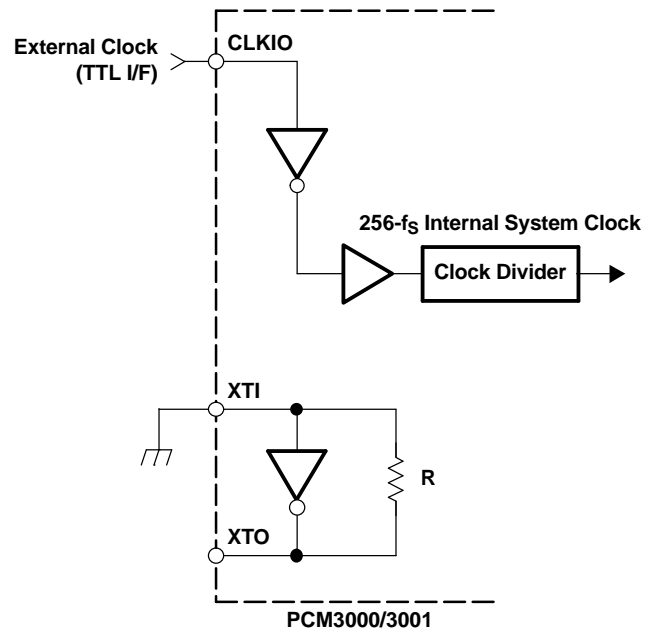

External Clock Input 2 : (XTO is open)

S0017-01

Figure 23. System Clock Connections

Table 1. System Clock Frequencies

SAMPLING RATE FREQUENCY (kHz)	SYSTEM CLOCK FREQUENCY (MHz)		
	256 f <sub>S</sub>	384 f <sub>S</sub>	512 f <sub>S</sub>
32	8.1920	12.2880	16.3840
44.1	11.2896	16.9344	22.5792
48	12.2880	18.4320	24.5760

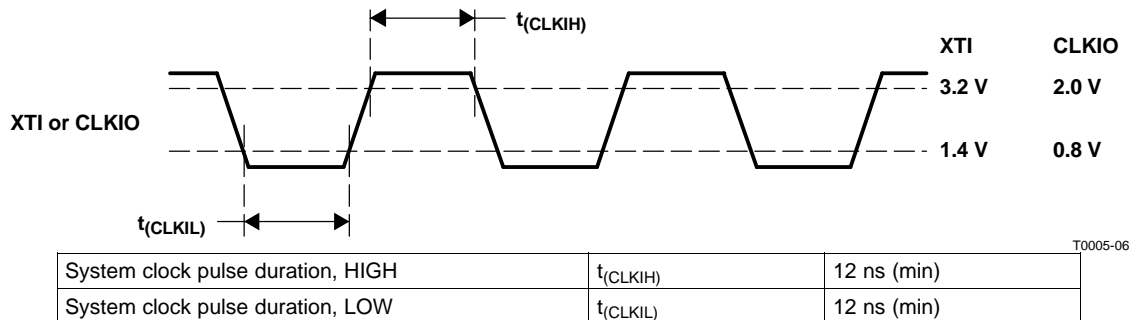

Figure 24. External System Clock Timing

POWER-ON RESET

The PCM3000/3001 has internal power-on reset circuitry. Power-on reset occurs when the system clock (XTI or CLKIO) is active and V<sub>DD</sub> > 4 V. For the PCM3001, the system clock must complete a minimum of 3 complete cycles prior to V<sub>DD</sub> > 4 V to ensure proper reset operation. The initialization sequence requires 1024 system cycles for completion, as shown in Figure 25. Figure 26 shows the state of the DAC and ADC outputs during and after the reset sequence.

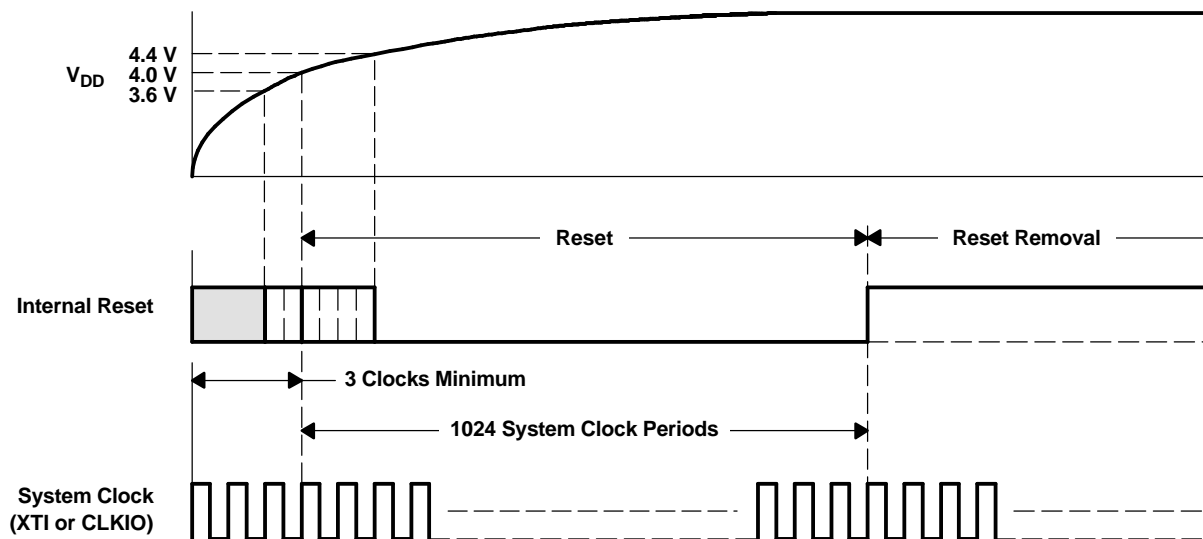
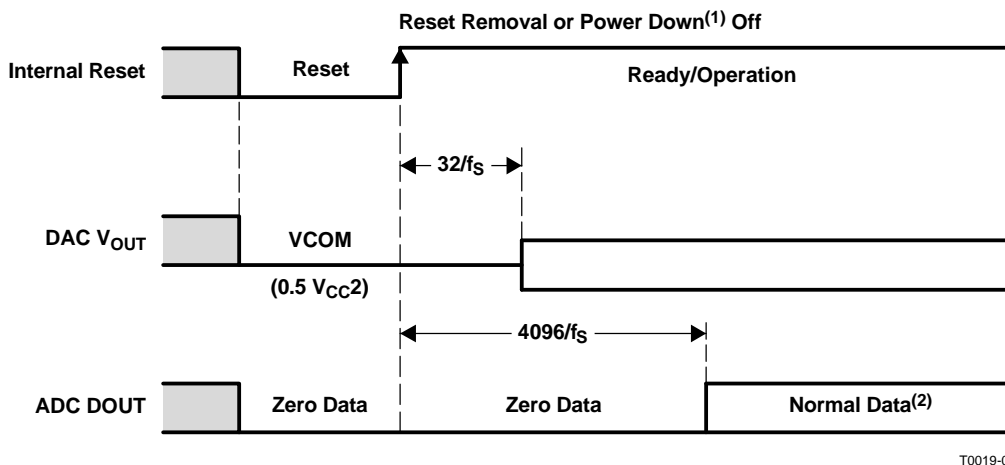

Figure 25. Internal Power-On Reset Timing





- (1) Power down is for PCM3000 only.
- (2) The HPF transient response (exponentially attenuated signal from  $\pm 1.5\%$  dc with 200-ms time constant) appears initially.

Figure 26. DAC Output and ADC Output for Reset and Power Down

## EXTERNAL RESET

The PCM3000/3001 includes a reset input, RSTB (pin 28). As shown in Figure 27, the external reset signal must drive RSTB low for a minimum of 40 nanoseconds while the system clock is active in order to initiate the reset sequence. Initialization starts on the rising edge of RSTB, and requires 1024 system clock cycles for completion. Figure 26 shows the state of the DAC and ADC outputs during and after the reset sequence.

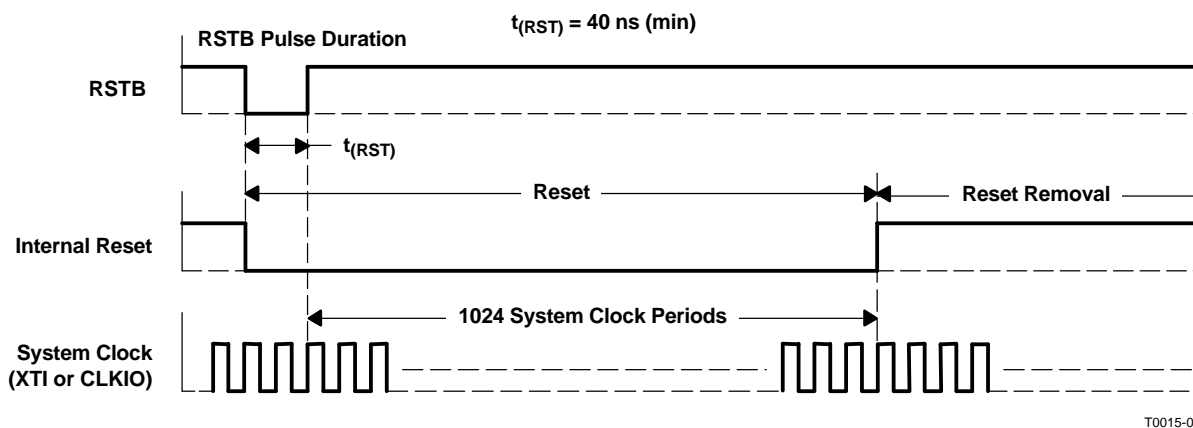
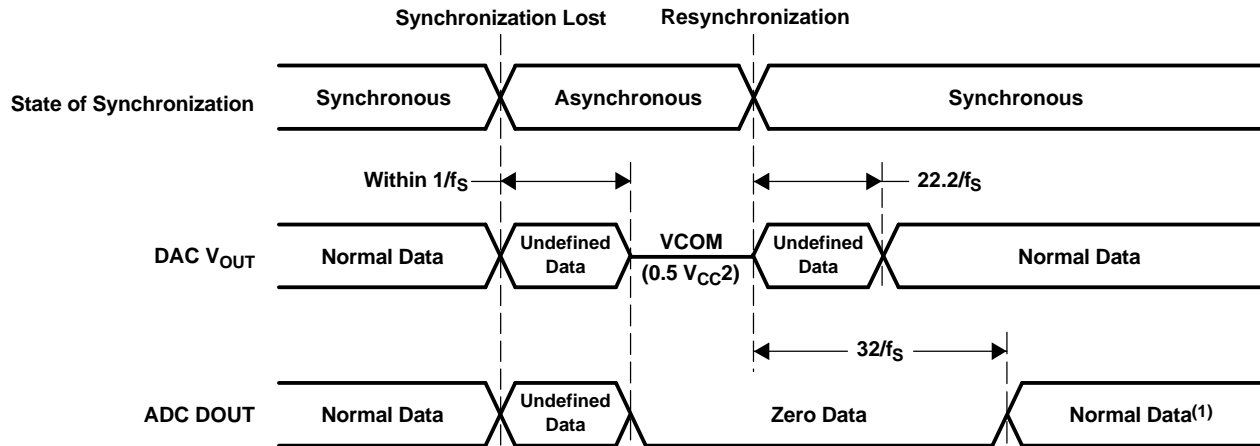

Figure 27. External Forced-Reset Timing

## SYNCHRONIZATION WITH THE DIGITAL AUDIO SYSTEM

The PCM3000/3001 operates with LRCIN synchronized to the system clock. The codec does not require any specific phase relationship between LRCIN and the system clock, but there must be synchronization of LRCIN and the system clock. If the synchronization between the system clock and LRCIN changes more than 6 bit clocks (BCKIN) during one sample (LRCIN) period because of phase jitter on LRCIN, internal operation of the DAC stops within  $1/f_s$ , and the analog output is forced to bipolar zero ( $V_{CC2}/2$ ) until the system clock is resynchronized to LRCIN. Internal operation of the ADC also stops within  $1/f_s$ , and the digital output codes are set to bipolar zero until resynchronization occurs. If LRCIN is synchronized within 5 or fewer bit clocks to the system clock, operation remains normal.

Figure 28 illustrates the effects on the output when synchronization is lost. Before the outputs are forced to bipolar zero ( $< 1/f_s$  seconds), the outputs are not defined and some noise may occur. During the transitions between normal data and undefined states, the output has discontinuities, which cause output noise.



T0020-04

- (1) The HPF transient response (exponentially attenuated signal from  $\pm 1.5\%$  dc with 200-ms time constant) appears initially.

Figure 28. DAC Output and ADC Output For Loss of Synchronization

## OPERATIONAL CONTROL

The PCM3000 can be controlled in the software mode with a three-wire serial interface on MC (pin 25), MD (pin 26), and ML (pin 27). Table 2 indicates selectable functions, and Figure 29 and Figure 30 illustrate control data input format and timing. The PCM3001 only allows for control of data format.

Table 2. Selectable Functions

FUNCTION	ADC/DAC	DEFAULT (PCM3000)
Audio data format (7 selectable formats)	ADC/DAC	DAC: 16-bit, MSB-first, right-justified ADC: 16-bit, MSB-first, left-justified
LRCIN polarity	ADC/DAC	Left/right = high/low
Loopback control	ADC/DAC	OFF
Left-channel attenuation	DAC	0 dB
Right-channel attenuation	DAC	0 dB
Attenuation control	DAC	Left channel and right channel = individual control
Infinite zero detection	DAC	OFF
DAC output control	DAC	Output enabled
Soft mute control	DAC	OFF
De-emphasis (OFF, 32 kHz, 44.1 kHz, 48 kHz)	DAC	OFF
Power-down control	ADC	OFF
High-pass filter operation	ADC	ON

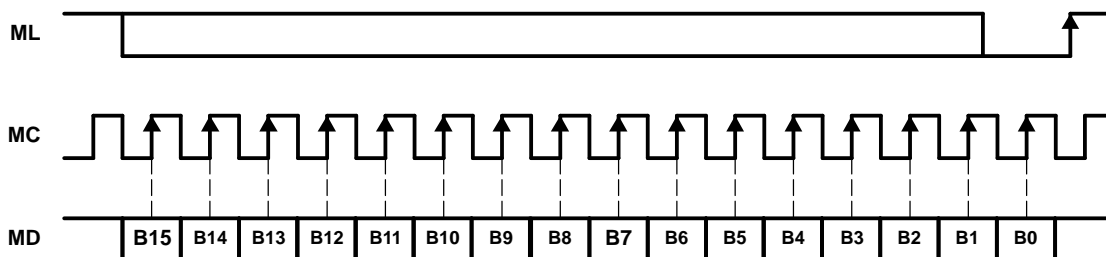

T0023-01

Figure 29. Control Data Input Format

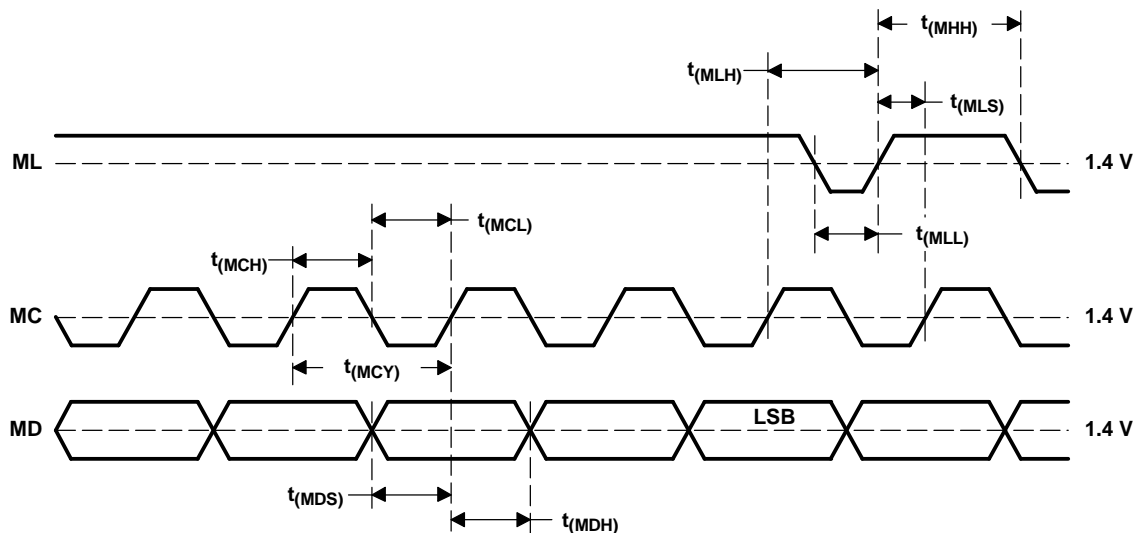

MC pulse cycle time	$t_{(MCY)}$	100 ns (min)
MC pulse duration, LOW	$t_{(MCL)}$	40 ns (min)
MC pulse duration, HIGH	$t_{(MCH)}$	40 ns (min)
MD setup time	$t_{(MDS)}$	40 ns (min)
MD hold time	$t_{(MDH)}$	40 ns (min)
ML low-level time	$t_{(MLL)}$	40 ns + 1 SYSCLK <sup>(1)</sup> (min)
ML high-level time	$t_{(MHH)}$	40 ns + 1 SYSCLK <sup>(1)</sup> (min)
ML setup time <sup>(2)</sup>	$t_{(MLS)}$	40 ns (min)
ML hold time <sup>(3)</sup>	$t_{(MLH)}$	40 ns (min)
SYSCLK (period): 1/256 $f_S$ or 1/384 $f_S$ or 1/512 $f_S$		

T0024-01

- (1) SYSCLK: system clock cycle  
 (2) ML rising edge to the next MC rising edge  
 (3) MC rising edge for LSB-to-ML rising edge

Figure 30. Control Data Input Timing

## MAPPING OF PROGRAM REGISTERS

	B15	B14	B13	B12	B11	B10	B9	B8	B7	B6	B5	B4	B3	B2	B1	B0
REGISTER 0	res	res	res	res	res	A1	A0	LDL	AL7	AL6	AL5	AL4	AL3	AL2	AL1	AL0
REGISTER 1	res	res	res	res	res	A1	A0	LDR	AR7	AR6	AR5	AR4	AR3	AR2	AR1	AR0
REGISTER 2	res	res	res	res	res	A1	A0	PDWN	BYPS	res	ATC	IZD	OUT	DEM1	DEM0	MUT
REGISTER 3	res	res	res	res	res	A1	A0	res	res	res	LOP	FMT2	FMT1	FMT0	LRP	res

NOTE: res indicates a reserved bit, which should be set to 0.

## PROGRAM REGISTER (PCM3000)

The software mode allows the user to control special functions. The PCM3000 special functions are controlled using four program registers which are each 16 bits long. There are four distinct registers, with bits 9 and 10 determining which register is in use. Table 3 describes the functions of the four registers.

**Table 3. Functions of the Registers**

REGISTER NAME	REGISTER BIT(S)	BIT NAME	DESCRIPTION
Register 0	15–11	res	Reserved, should be set to 0
	10–9	A[1:0]	Register address 00
	8	LDL	DAC attenuation data load control for Lch
	7–0	AL[7:0]	DAC attenuation data for Lch
Register 1	15–11	res	Reserved, should be set to 0
	10–9	A[1:0]	Register address 01
	8	LDR	DAC attenuation data load control for Rch
	7–0	AR[7:0]	DAC attenuation data for Rch
Register 2	15–11	res	Reserved, should be set to 0
	10–9	A[1:0]	Register address 10
	8	PDWN	ADC power-down control
	7	BYPS	ADC high-pass filter bypass control
	6	res	Reserved, should be set to 0
	5	ATC	DAC attenuation data mode control
	4	IZD	DAC infinite zero detection circuit control
	3	OUT	DAC output enable control
	2–1	DEM[1:0]	DAC de-emphasis control
	0	MUT	DAC Lch and Rch soft mute control
Register 3	15–11	res	Reserved, should be set to 0
	10–9	A[1:0]	Register address 11
	8–6	res	Reserved, should be set to 0
	5	LOP	ADC/DAC analog loopback control
	4–2	FMT[2:0]	ADC/DAC audio data format selection
	1	LRP	ADC/DAC polarity of LR-clock selection
	0	res	Reserved, should be set to 0

**PROGRAM REGISTER 0**

**res:** Bits 15:11 – Reserved  
These bits are reserved and should be set to 0.

**A[1:0]:** Bits 10:9 – Register Address  
These bits define the address for REGISTER 0:

A1	A0	
0	0	Register 0

**LDL:** Bit 8 – DAC Attenuation Data Load Control for Left Channel  
This bit is used to simultaneously set the analog outputs of the left and right channels. The output level is controlled by AL[7:0] attenuation data when this bit is set to 1. When set to 0, the new attenuation data is stored into a register, and the output level remains at the previous attenuation level. The LDR bit in REGISTER 1 has the equivalent function as LDL. When either LDL or LDR is set to 1, the output levels of the left and right channels are simultaneously controlled.

**AL[7:0]:** Bits 7:0 – DAC Attenuation Data for Left Channel

AL7 and AL0 are the MSB and LSB, respectively. The attenuation level (ATT) is given by

$$ATT = 20 \times \log_{10} (AL[7:0]/256) \text{ (dB), except } AL[7:0] = FFh$$

AL[7:0]	ATTENUATION LEVEL
00h	–∞ dB (mute)
01h	–48.16 dB
:	:
FEh	–0.07 dB
FFh	0 dB (default)

### PROGRAM REGISTER 1

**res:** Bits 15:11 – Reserved

These bits are reserved and should be set to 0.

**A[1:0]:** Bits 10:9 – Register Address

These bits define the address for REGISTER 1.

A1	A0	
0	1	Register 1

**LDR:** Bit 8 – DAC Attenuation Data Load Control for Right Channel

This bit is used to simultaneously set the analog outputs of the left and right channels. The output level is controlled by AR[7:0] attenuation data when this bit is set to 1. When set to 0, the new attenuation data is stored into a register, and the output level remains at the previous attenuation level. The LDL bit in REGISTER 0 has the equivalent function as LDR. When either LDL or LDR is set to 1, the output levels of the left and right channels are simultaneously controlled.

**AR[7:0]:** Bits 7:0 – DAC Attenuation Data for Right Channel

AR7 and AR0 are the MSB and LSB, respectively. The attenuation level (ATT) is given by

$$ATT = 20 \times \log_{10} (AR[7:0]/256) \text{ (dB), except } AR[7:0] = FFh$$

AR[7:0]	ATTENUATION LEVEL
00h	–∞ dB (mute)
01h	–48.16 dB
:	:
FEh	–0.07 dB
FFh	0 dB (default)

### PROGRAM REGISTER 2

**res:** Bits 15:11 – Reserved

These bits are reserved and should be set to 0.

**A[1:0]:** Bits 10:9 – Register Address

These bits define the address for REGISTER 2:

A1	A0	
1	0	Register 2

**PDWN:** Bit 8 – ADC Power-Down Control

This bit places the ADC section in a power-down mode, forcing the output data to all zeroes. This has no effect on the DAC section or the contents of the mode registers.

PDWN	
0	Power-down mode disabled (default)
1	Power-down mode enabled

**BYPS:** Bit 7 – ADC High-Pass Filter Bypass Control

This bit enables or disables the high-pass filter for the ADC.

BYPS	
0	High-pass filter enabled (default)
1	High-pass filter disabled (bypassed)

**res:** Bit 6 – Reserved

This bit is reserved and should be set to 0.

**ATC:** Bit 5 – DAC Attenuation Data Mode Control

When set to 1, the REGISTER 0 attenuation data is used for both DAC channels. In this case, the REGISTER 1 attenuation data is ignored.

ATC	
0	Individual channel attenuation data control (default)
1	Common channel attenuation data control

**IZD:** Bit 4 – DAC Infinite Zero Detection Circuit Control

This bit enables the infinite zero detection circuit in the PCM3000. When enabled, this circuit disconnects the analog output amplifier from the delta-sigma DAC when the input is continuously zero for 65,536 consecutive cycles of BCKIN.

IZD	
0	Infinite zero detection disabled (default)
1	Infinite zero detection enabled

**OUT:** Bit 3 – DAC Output Enable Control

When set to 1, the outputs are forced to  $V_{CC}/2$  (bipolar zero). In this case, all registers in the PCM3000 hold the present data. Therefore, when set to 0, the outputs return to the previous programmed state.

OUT	
0	DAC outputs enabled (default normal operation)
1	DAC outputs disabled (forced to BPZ)

**DEM[1:0]:** Bits 2:1 – DAC De-Emphasis Control

These bits select the de-emphasis mode as shown.

DEM1	DEM0	
0	0	De-emphasis OFF (default)
0	1	De-emphasis 48 kHz ON
1	0	De-emphasis 44.1 kHz ON
1	1	De-emphasis 32 kHz ON

**MUT:** Bit 0 – DAC Soft Mute Control

When set to 1, both left- and right-channel DAC outputs are muted at the same time. This muting is done by attenuating the data in the digital filter, so that there is no audible click noise when soft mute is turned on.

MUT	
0	Mute disabled (default)
1	Mute enabled

### PROGRAM REGISTER 3

**res:** Bits 15:11 – Reserved  
These bits are reserved and should be set to 0.

**A[1:0]:** Bits 10:9 – Register Address

These bits define the address for REGISTER 3.

A1	A0	
1	1	Register 3

**res:** Bits 8:6 – Reserved  
These bits are reserved and should be set to 0.

**LOP:** Bit 5 – ADC to DAC Loopback Control

When this bit is set to 1, the ADC audio data is sent directly to the DAC. The data format defaults to I<sup>2</sup>S; DOUT is still available in loopback mode.

LOP	
0	Loopback disabled (default)
1	Loopback enabled

**FMT[2:0]:** Bits 4:2 – Audio Data Format Select

These bits determine the input and output audio data formats. (default: FMT[2:0] = 000<sub>b</sub>)

FM2	FMT1	FMT0	DAC DATA FORMAT	ADC DATA FORMAT
0	0	0	16-bit, MSB-first, right-justified	16-bit, MSB-first, left-justified
0	0	1	18-bit, MSB-first, right-justified	18-bit, MSB-first, left-justified
0	1	0	16-bit, MSB-first, right-justified	16-bit, MSB-first, right-justified
0	1	1	18-bit, MSB-first, right-justified	18-bit, MSB-first, right-justified
1	0	0	16-/18-bit, MSB-first, left-justified	18-bit, MSB-first, left-justified
1	0	1	16-/18-bit, MSB-first, I <sup>2</sup> S	18-bit, MSB-first, I <sup>2</sup> S
1	1	0	16-bit, MSB-first, DSP-frame	16-bit, MSB-first, DSP-frame
1	1	1	Reserved	Reserved

**LRP:** Bit 1 – ADC-to-DAC LRCK Polarity Select

Polarity of LRCIN applies only to formats 0 through 4.

LOP	
0	Left channel is H, right channel is L (default).
1	Left channel is L, right channel is H.

**res:** Bit 0 – Reserved  
This bit is reserved and should be set to 0.

### PCM3001 DATA FORMAT CONTROL

The input and output data formats are controlled by pins 27 (FMT0), 26 (FMT1), and 25 (FMT2). Set these pins to the same values shown for the bit-mapped PCM3000 controls in program register 3.

## THEORY OF OPERATION

### ADC SECTION

The PCM3000/3001 ADC consists of a band-gap reference, a stereo single-to-differential converter, a fully differential 5th-order delta-sigma modulator, a decimation filter (including digital high pass), and a serial interface circuit. The block diagram in this data sheet illustrates the architecture of the ADC section. Figure 17 shows the single-to-differential converter, and Figure 31 illustrates the architecture of the 5th-order delta-sigma modulator and transfer functions.

An internal high-precision reference with two external capacitors provides all reference voltages required by the ADC, which defines the full scale range for the converter. The internal single-to-differential voltage converter saves the space and extra parts needed for external circuitry which is required by many delta-sigma converters. The internal full-differential signal processing architecture provides a wide dynamic range and excellent power supply rejection performance.

The input signal is sampled at a  $64\times$  oversampling rate, eliminating the need for a sample-and-hold circuit, and simplifying antialias filtering requirements. The 5th-order delta-sigma noise shaper consists of five integrators which use a switched-capacitor topology, a comparator, and a feedback loop consisting of a one-bit DAC. The delta-sigma modulator shapes the quantization noise, shifting it out of the audio band in the frequency domain. The high order of the modulator enables it to randomize the modulator outputs, reducing idle tone levels.

The  $64\text{-}f_s$  1-bit data stream from the modulator is converted to  $1\text{-}f_s$ , 18-bit data words by the decimation filter, which also acts as a low-pass filter to remove the shaped quantization noise. The dc components are removed by a high-pass filter function contained within the decimation filter.

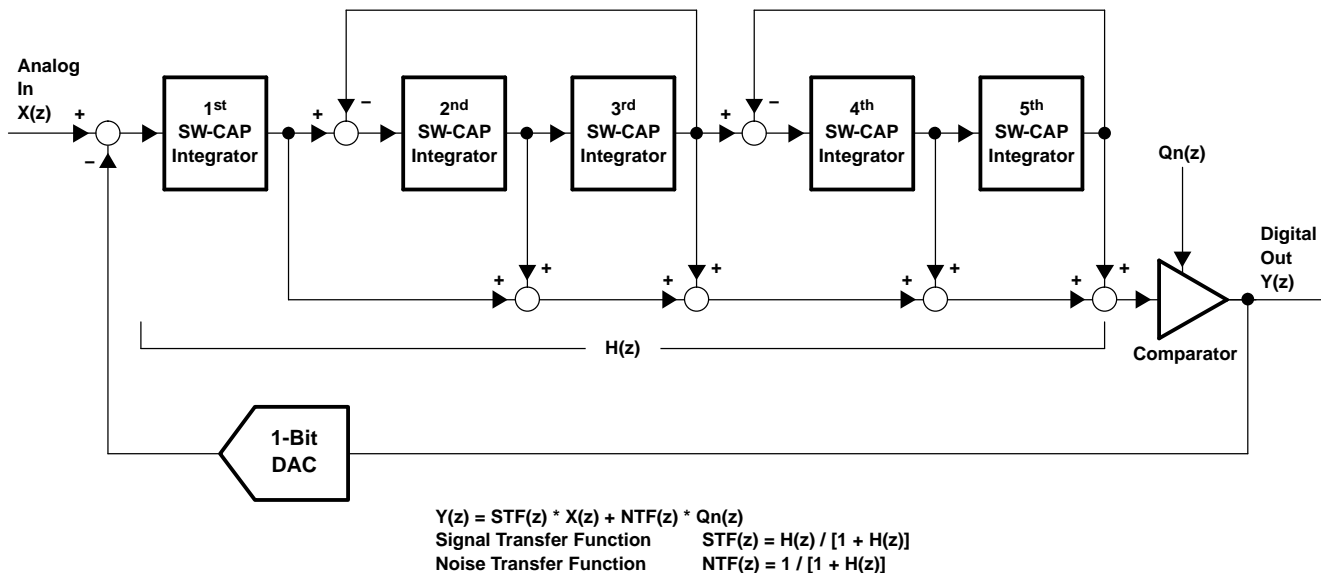

B0005-01

Figure 31. Simplified Fifth-Order Delta-Sigma Modulator

### DAC SECTION

The delta-sigma DAC section of the PCM3000/3001 is based on a 5-level amplitude quantizer and a 3rd-order noise shaper. This section converts the oversampled input data to a 5-level delta-sigma format. A block diagram of the 5-level delta-sigma modulator is shown in Figure 32. This 5-level delta-sigma modulator has the advantage of improved stability and reduced clock-jitter sensitivity over the typical one-bit (2-level) delta-sigma modulator.

The combined oversampling rate of the delta-sigma modulator and the internal  $8\times$  interpolation filter is  $64 f_s$  for a  $256\text{-}f_s$  system clock. The theoretical quantization noise performance of the 5-level delta-sigma modulator is shown in Figure 33.



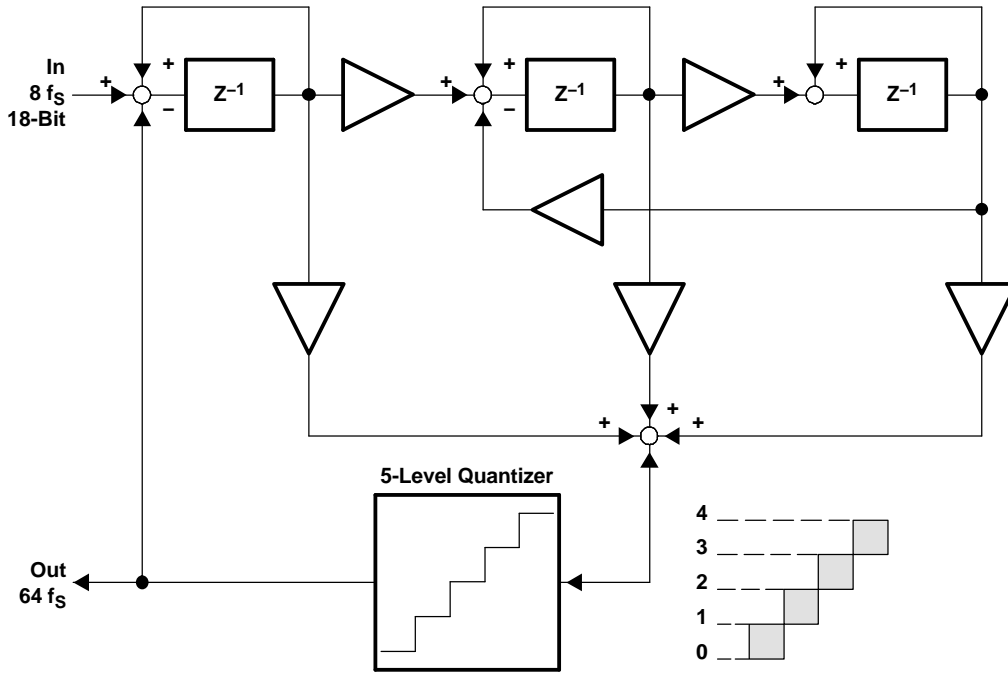

B0008-02

Figure 32. 5-Level  $\Delta\Sigma$  Modulator Block Diagram

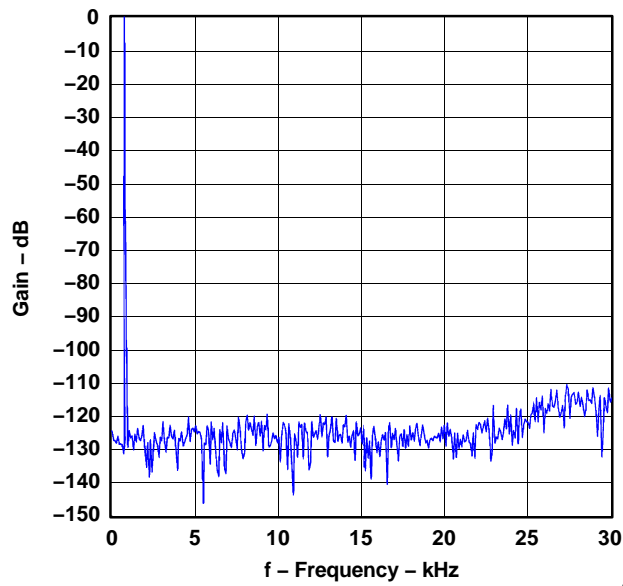

G027

Figure 33. Quantization Noise Spectrum

## APPLICATION INFORMATION

### APPLICATION AND LAYOUT CONSIDERATIONS

#### TYPICAL CONNECTION

A typical connection diagram for the PCM3000/3001 is shown in Figure 34.

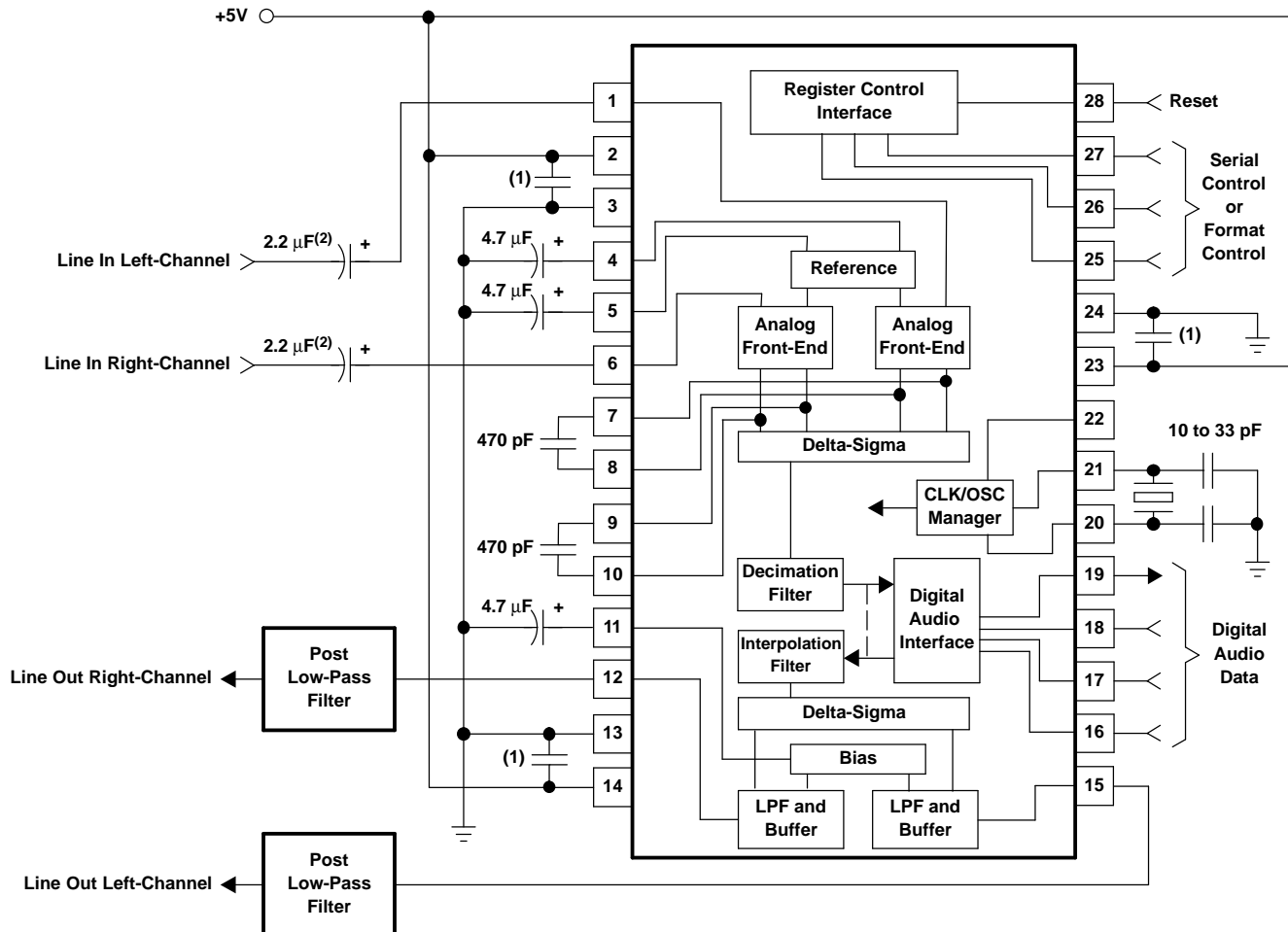

S0018-01

(1) Bypass capacitor = 0.1  $\mu$ F and 10  $\mu$ F.

(2) The input capacitor affects the pole of the HPF. Example: 2.2  $\mu$ F sets the cutoff frequency to 4.8 Hz, with a 66-ms time constant.

Figure 34. Typical Connection Diagram for PCM3000/3001

#### POWER SUPPLY BYPASSING

The digital and analog power-supply lines to the PCM3000/3001 should be bypassed to the corresponding ground pins with both 0.1- $\mu$ F ceramic and 10- $\mu$ F tantalum capacitors as close to the device pins as possible to maximize the performance of the ADC and DAC. Although the PCM3000/3001 has three power supply lines to optimize dynamic performance, the use of one common power supply is generally recommended to avoid unexpected latch-up or pop noise due to power-supply sequencing problems. If separate power supplies are used, back-to-back diodes between the two power sources near the device are recommended to avoid latch-up problems.

## APPLICATION INFORMATION (continued)

### GROUNDING

In order to optimize dynamic performance of the PCM3000/3001, the analog and digital grounds are not internally connected. PCM3000/3001 performance is optimized with a single ground plane for all returns. It is recommended to tie all PCM3000/3001 ground pins to the analog ground plane using low-impedance connections. The PCM3000/3001 should reside entirely over this plane to avoid coupling high-frequency digital switching noise into the analog ground plane.

### VOLTAGE INPUTS

A tantalum or aluminum electrolytic capacitor, between 2.2  $\mu\text{F}$  and 10  $\mu\text{F}$ , is recommended as an ac-coupling capacitor at the inputs. Combined with the 15-k $\Omega$  characteristic input impedance, a 2.2- $\mu\text{F}$  coupling capacitor establishes a 4.8-Hz cutoff frequency for blocking dc. The input voltage range can be increased by adding a series resistor on the analog input line. This series resistor, when combined with the 15-k $\Omega$  input impedance, creates a voltage divider and enables larger input ranges.

### V<sub>REF</sub> INPUTS

A 4.7- $\mu\text{F}$  to 10- $\mu\text{F}$  tantalum capacitor is recommended between V<sub>REFL</sub>, V<sub>REFR</sub>, and AGND1 to ensure low source impedance for the ADC references. These capacitors should be located as close as possible to the reference pins to reduce dynamic errors on the ADC reference.

### C<sub>INP</sub> AND C<sub>INN</sub> INPUTS

A 470-pF to 1000-pF film or NPO ceramic capacitor is recommended between C<sub>INPL</sub> and C<sub>INNL</sub>, and also between C<sub>INPR</sub> and C<sub>INNR</sub> to create an antialias filter that has a 170-kHz to 80-kHz cutoff frequency. These capacitors should be located as close as possible to the C<sub>INP</sub> and C<sub>INN</sub> pins to avoid introducing undesirable noise or dynamic errors into the delta-sigma modulator.

### VCOM INPUT

A 4.7- $\mu\text{F}$  to 10- $\mu\text{F}$  tantalum capacitor is recommended between VCOM and AGND2 to ensure low source impedance of the DAC output common. This capacitor should be located as close as possible to the VCOM pin to reduce dynamic errors on the DAC common.

### SYSTEM CLOCK

The quality of the system clock can influence the dynamic performance of both the ADC and DAC in the PCM3000/3001. The duty cycle, jitter, and threshold voltage at the system clock input pin should be carefully managed. When power is supplied to the part, the system clock, bit clock (BCKIN), and word clock (LCRIN) must also be supplied simultaneously. Failure to supply the audio clocks results in a power dissipation increase of up to three times normal dissipation and may degrade long-term reliability if the maximum power dissipation limit is exceeded.

### RSTB CONTROL

If capacitors greater than 4.7  $\mu\text{F}$  are used on V<sub>REF</sub> and VCOM, an external reset control with delay time corresponding to the V<sub>REF</sub>, VCOM response is required.

**PACKAGING INFORMATION**

Orderable Device	Status <sup>(1)</sup>	Package Type	Package Drawing	Pins	Package Qty	Eco Plan <sup>(2)</sup>	Lead/Ball Finish	MSL Peak Temp <sup>(3)</sup>
PCM3000E	ACTIVE	SSOP	DB	28	47	Green (RoHS & no Sb/Br)	CU NIPDAU	Level-1-260C-UNLIM
PCM3000E/2K	ACTIVE	SSOP	DB	28	2000	Green (RoHS & no Sb/Br)	CU NIPDAU	Level-1-260C-UNLIM
PCM3000E/2KG4	ACTIVE	SSOP	DB	28	2000	Green (RoHS & no Sb/Br)	CU NIPDAU	Level-1-260C-UNLIM
PCM3000EG4	ACTIVE	SSOP	DB	28	47	Green (RoHS & no Sb/Br)	CU NIPDAU	Level-1-260C-UNLIM
PCM3001E	ACTIVE	SSOP	DB	28	47	Green (RoHS & no Sb/Br)	CU NIPDAU	Level-1-260C-UNLIM
PCM3001E/2K	ACTIVE	SSOP	DB	28	2000	Green (RoHS & no Sb/Br)	CU NIPDAU	Level-1-260C-UNLIM
PCM3001E/2KG4	ACTIVE	SSOP	DB	28	2000	Green (RoHS & no Sb/Br)	CU NIPDAU	Level-1-260C-UNLIM
PCM3001EG/2K	ACTIVE					Pb-Free (RoHS)	CU SNBI	Level-1-260C-UNLIM
PCM3001EG4	ACTIVE	SSOP	DB	28	47	Green (RoHS & no Sb/Br)	CU NIPDAU	Level-1-260C-UNLIM

<sup>(1)</sup> The marketing status values are defined as follows:

**ACTIVE:** Product device recommended for new designs.

**LIFEBUY:** TI has announced that the device will be discontinued, and a lifetime-buy period is in effect.

**NRND:** Not recommended for new designs. Device is in production to support existing customers, but TI does not recommend using this part in a new design.

**PREVIEW:** Device has been announced but is not in production. Samples may or may not be available.

**OBSELETE:** TI has discontinued the production of the device.

<sup>(2)</sup> Eco Plan - The planned eco-friendly classification: Pb-Free (RoHS), Pb-Free (RoHS Exempt), or Green (RoHS & no Sb/Br) - please check <http://www.ti.com/productcontent> for the latest availability information and additional product content details.

**TBD:** The Pb-Free/Green conversion plan has not been defined.

**Pb-Free (RoHS):** TI's terms "Lead-Free" or "Pb-Free" mean semiconductor products that are compatible with the current RoHS requirements for all 6 substances, including the requirement that lead not exceed 0.1% by weight in homogeneous materials. Where designed to be soldered at high temperatures, TI Pb-Free products are suitable for use in specified lead-free processes.

**Pb-Free (RoHS Exempt):** This component has a RoHS exemption for either 1) lead-based flip-chip solder bumps used between the die and package, or 2) lead-based die adhesive used between the die and leadframe. The component is otherwise considered Pb-Free (RoHS compatible) as defined above.

**Green (RoHS & no Sb/Br):** TI defines "Green" to mean Pb-Free (RoHS compatible), and free of Bromine (Br) and Antimony (Sb) based flame retardants (Br or Sb do not exceed 0.1% by weight in homogeneous material)

<sup>(3)</sup> MSL, Peak Temp. -- The Moisture Sensitivity Level rating according to the JEDEC industry standard classifications, and peak solder temperature.

**Important Information and Disclaimer:**The information provided on this page represents TI's knowledge and belief as of the date that it is provided. TI bases its knowledge and belief on information provided by third parties, and makes no representation or warranty as to the accuracy of such information. Efforts are underway to better integrate information from third parties. TI has taken and continues to take reasonable steps to provide representative and accurate information but may not have conducted destructive testing or chemical analysis on incoming materials and chemicals. TI and TI suppliers consider certain information to be proprietary, and thus CAS numbers and other limited information may not be available for release.

In no event shall TI's liability arising out of such information exceed the total purchase price of the TI part(s) at issue in this document sold by TI to Customer on an annual basis.

**TAPE AND REEL INFORMATION**



**QUADRANT ASSIGNMENTS FOR PIN 1 ORIENTATION IN TAPE**



\*All dimensions are nominal

Device	Package Type	Package Drawing	Pins	SPQ	Reel Diameter (mm)	Reel Width W1 (mm)	A0 (mm)	B0 (mm)	K0 (mm)	P1 (mm)	W (mm)	Pin1 Quadrant
PCM3000E/2K	SSOP	DB	28	2000	330.0	17.4	8.5	10.8	2.4	12.0	16.0	Q1
PCM3001E/2K	SSOP	DB	28	2000	330.0	17.4	8.5	10.8	2.4	12.0	16.0	Q1

**TAPE AND REEL BOX DIMENSIONS**



\*All dimensions are nominal

Device	Package Type	Package Drawing	Pins	SPQ	Length (mm)	Width (mm)	Height (mm)
PCM3000E/2K	SSOP	DB	28	2000	336.6	336.6	28.6
PCM3001E/2K	SSOP	DB	28	2000	336.6	336.6	28.6



## IMPORTANT NOTICE

Texas Instruments Incorporated and its subsidiaries (TI) reserve the right to make corrections, modifications, enhancements, improvements, and other changes to its products and services at any time and to discontinue any product or service without notice. Customers should obtain the latest relevant information before placing orders and should verify that such information is current and complete. All products are sold subject to TI's terms and conditions of sale supplied at the time of order acknowledgment.

TI warrants performance of its hardware products to the specifications applicable at the time of sale in accordance with TI's standard warranty. Testing and other quality control techniques are used to the extent TI deems necessary to support this warranty. Except where mandated by government requirements, testing of all parameters of each product is not necessarily performed.

TI assumes no liability for applications assistance or customer product design. Customers are responsible for their products and applications using TI components. To minimize the risks associated with customer products and applications, customers should provide adequate design and operating safeguards.

TI does not warrant or represent that any license, either express or implied, is granted under any TI patent right, copyright, mask work right, or other TI intellectual property right relating to any combination, machine, or process in which TI products or services are used. Information published by TI regarding third-party products or services does not constitute a license from TI to use such products or services or a warranty or endorsement thereof. Use of such information may require a license from a third party under the patents or other intellectual property of the third party, or a license from TI under the patents or other intellectual property of TI.

Reproduction of TI information in TI data books or data sheets is permissible only if reproduction is without alteration and is accompanied by all associated warranties, conditions, limitations, and notices. Reproduction of this information with alteration is an unfair and deceptive business practice. TI is not responsible or liable for such altered documentation. Information of third parties may be subject to additional restrictions.

Resale of TI products or services with statements different from or beyond the parameters stated by TI for that product or service voids all express and any implied warranties for the associated TI product or service and is an unfair and deceptive business practice. TI is not responsible or liable for any such statements.

TI products are not authorized for use in safety-critical applications (such as life support) where a failure of the TI product would reasonably be expected to cause severe personal injury or death, unless officers of the parties have executed an agreement specifically governing such use. Buyers represent that they have all necessary expertise in the safety and regulatory ramifications of their applications, and acknowledge and agree that they are solely responsible for all legal, regulatory and safety-related requirements concerning their products and any use of TI products in such safety-critical applications, notwithstanding any applications-related information or support that may be provided by TI. Further, Buyers must fully indemnify TI and its representatives against any damages arising out of the use of TI products in such safety-critical applications.

TI products are neither designed nor intended for use in military/aerospace applications or environments unless the TI products are specifically designated by TI as military-grade or "enhanced plastic." Only products designated by TI as military-grade meet military specifications. Buyers acknowledge and agree that any such use of TI products which TI has not designated as military-grade is solely at the Buyer's risk, and that they are solely responsible for compliance with all legal and regulatory requirements in connection with such use.

TI products are neither designed nor intended for use in automotive applications or environments unless the specific TI products are designated by TI as compliant with ISO/TS 16949 requirements. Buyers acknowledge and agree that, if they use any non-designated products in automotive applications, TI will not be responsible for any failure to meet such requirements.

Following are URLs where you can obtain information on other Texas Instruments products and application solutions:

### Products

Amplifiers	<a href="http://amplifier.ti.com">amplifier.ti.com</a>
Data Converters	<a href="http://dataconverter.ti.com">dataconverter.ti.com</a>
DSP	<a href="http://dsp.ti.com">dsp.ti.com</a>
Clocks and Timers	<a href="http://www.ti.com/clocks">www.ti.com/clocks</a>
Interface	<a href="http://interface.ti.com">interface.ti.com</a>
Logic	<a href="http://logic.ti.com">logic.ti.com</a>
Power Mgmt	<a href="http://power.ti.com">power.ti.com</a>
Microcontrollers	<a href="http://microcontroller.ti.com">microcontroller.ti.com</a>
RFID	<a href="http://www.ti-rfid.com">www.ti-rfid.com</a>
RF/IF and ZigBee® Solutions	<a href="http://www.ti.com/lprf">www.ti.com/lprf</a>

### Applications

Audio	<a href="http://www.ti.com/audio">www.ti.com/audio</a>
Automotive	<a href="http://www.ti.com/automotive">www.ti.com/automotive</a>
Broadband	<a href="http://www.ti.com/broadband">www.ti.com/broadband</a>
Digital Control	<a href="http://www.ti.com/digitalcontrol">www.ti.com/digitalcontrol</a>
Medical	<a href="http://www.ti.com/medical">www.ti.com/medical</a>
Military	<a href="http://www.ti.com/military">www.ti.com/military</a>
Optical Networking	<a href="http://www.ti.com/opticalnetwork">www.ti.com/opticalnetwork</a>
Security	<a href="http://www.ti.com/security">www.ti.com/security</a>
Telephony	<a href="http://www.ti.com/telephony">www.ti.com/telephony</a>
Video & Imaging	<a href="http://www.ti.com/video">www.ti.com/video</a>
Wireless	<a href="http://www.ti.com/wireless">www.ti.com/wireless</a>

Mailing Address: Texas Instruments, Post Office Box 655303, Dallas, Texas 75265  
Copyright © 2008, Texas Instruments Incorporated